

13' x 20' x 12' Garage-in-a-Box SUV/Truck[®] Peak Style Shelter Assembly Instructions

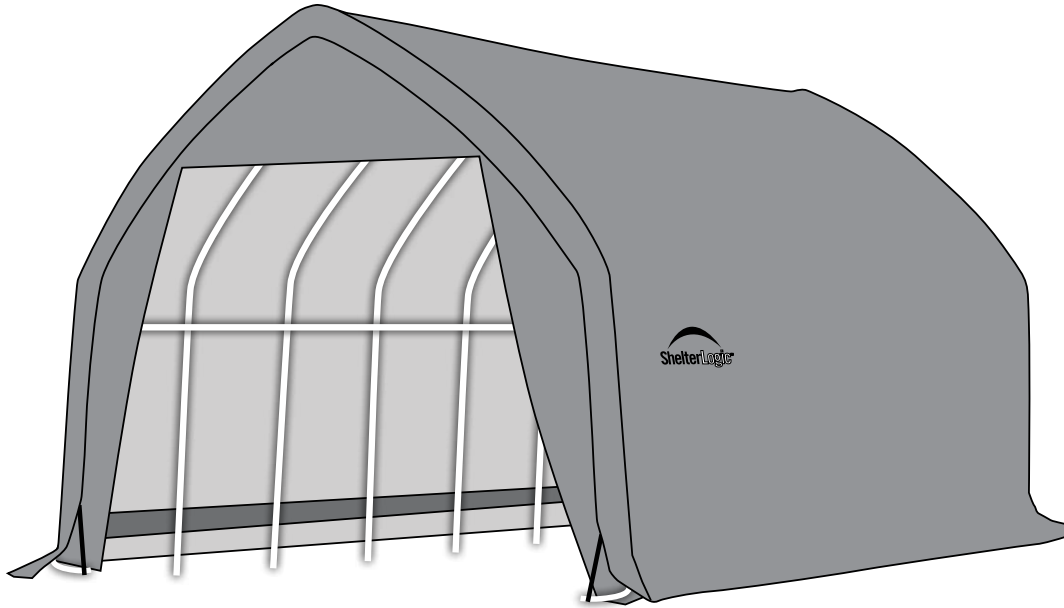

DESCRIPTION	MODEL #
13' x 20' x 12' Garage-in-a-Box SUV/Truck [®] - Gray	62693

RECOMMENDED TOOLS

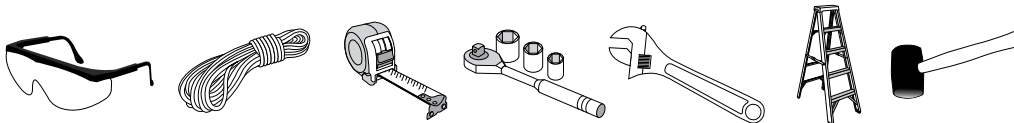

Please read instructions **COMPLETELY** before assembly. This shelter **MUST** be securely anchored. **THIS IS A TEMPORARY STRUCTURE AND NOT RECOMMENDED AS A PERMANENT STRUCTURE.**

Before you start: 2+ individual recommended for assembly, approximate time 2 hr.

150 Callender Road
Watertown, CT 06795
www.shelterlogic.com

1-800-524-9970

Canada:
1-800-559-6175

ATTENTION:

This shelter product is manufactured with quality materials. It is designed to fit the **ShelterLogic®**, LLC custom fabric cover included. **ShelterLogic®**, LLC Shelters offer storage and protection from damage caused by sun, light rain, tree sap, animal - bird excrement and light snow. Please anchor this **ShelterLogic®**, LLC structure properly. See manual for more anchoring details. Proper anchoring, keeping cover tight and free of snow and debris is the responsibility of the consumer. Please read and understand the installation detail, warnings and cautions prior to beginning installation. If you have any questions call the customer service number listed below. Please refer to the warranty card inside this package.

DANGER:

Prior to installation, consult with all local municipal codes regarding installation of temporary shelters. Choose the location of your shelter carefully. **DANGER: Keep away from electrical wires.** Check for overhead utility lines, tree branches or other structures. Check for underground pipes or wires before you dig. DO NOT install near roof lines or other structures that could shed snow, ice or excessive run off onto your shelter. DO NOT hang objects from the roof or support cables.



WARNING:

Risk of fire. DO NOT smoke or use open flame devices (including grills, fire pits, deep fryers, smokers or lanterns) in or around the shelter. DO NOT store flammable liquids (gasoline, kerosene, propane, etc.) in or around your shelter. Do not expose top or sides of the shelter to open fire or other flame source.

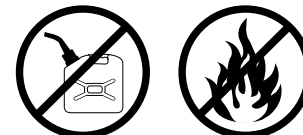

CAUTION:

Use **CAUTION** when erecting the frame. Use safety goggles during installation. Secure and bolt together overhead poles during assembly. Beware of pole ends.

PROPER ANCHORING AND INSTALLATION OF FRAME:

PROPER ANCHORING OF THE FRAME IS THE RESPONSIBILITY OF THE CONSUMER.

ShelterLogic®, LLC is not responsible for damage to the unit or the contents from acts of nature. Any shelter that is not anchored securely has the potential to fly away causing damage, and is not covered under the warranty. Periodically check the anchors to ensure stability of shelter. **ShelterLogic®**, LLC cannot be responsible for any shelter that blows away. **NOTE:** *Your shelter's cover can be quickly removed and stored prior to severe weather conditions.* If strong winds or severe weather is forecast in your area, we recommend removal of cover.

REPLACEMENT PARTS, ASSEMBLY, SPECIAL ORDERS:

Genuine **ShelterLogic®**, LLC replacement parts and accessories are available from the factory, including anchoring kits for nearly any application, replacement covers, wall and enclosure kits, vent and light kits, frame parts, zippered doors and other accessories. All items are shipped factory direct to your door.

QUESTIONS - CLAIMS - SPECIAL ORDERS? CALL OUR CUSTOMER SERVICE HOTLINE:

U.S. CUSTOMER SERVICE: 1-800-524-9970 INTERNATIONAL CUSTOMER SERVICE: 001-860-945-6442 CANADA CUSTOMER SERVICE: 1-800-559-6175

HOURS OF OPERATION: MON-FRI 8:30AM-8:00PM EST, SAT-SUN 8:30AM-5:00PM EST.

CARE AND CLEANING:

A tight cover ensures longer life and performance. Always maintain a tight cover. Loose fabric can accelerate deterioration of cover fabric. Immediately remove any accumulated snow or ice from the roof structure with a broom, mop or other soft-sided instrument. Use extreme caution when removing snow from cover- always remove from outside the structure. DO NOT use hard-edged tools or instruments like rakes or shovels to remove snow. This could result in punctures to the cover. DO NOT use bleach or harsh abrasive products to clean the fabric cover. Cover is easily cleaned with mild soap and water.

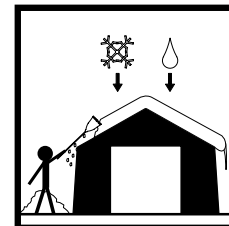













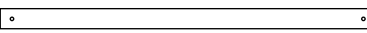
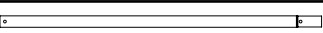

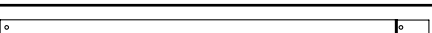
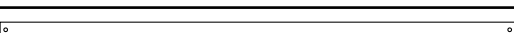
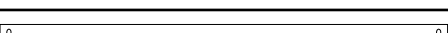
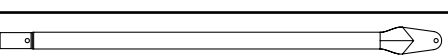
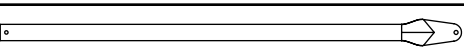







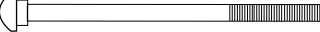

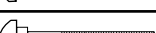



WARRANTY:

This shelter carries a full limited warranty against defects in workmanship. **ShelterLogic®**, LLC warrants to the Original Purchaser that if properly used and installed, the product and all associated parts, are free from manufacturer's defects for a period of:

1 YEAR FOR COVER FABRIC, END PANELS AND FRAMEWORK

Warranty period is determined by date of shipment from **ShelterLogic®**, LLC for factory direct purchases or date of purchase from an authorized reseller, (please save a copy of your purchase receipt). If this product or any associated parts are found to be defective or missing at the time of receipt, **ShelterLogic®**, LLC will repair or replace, at it's option, the defective parts at no charge to the original purchaser. Replacement parts or repaired parts shall be covered for the remainder of the Original Limited Warranty Period. All shipping costs will be the responsibility of the customer. Parts and replacements will be sent C.O.D. You must save the original packaging materials for shipment back. If you purchased from a local dealer, all claims must have a copy of original receipt. After purchase, please fill out and return warranty card for product registration. Please see warranty card for more details.

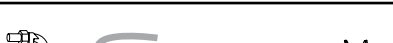
13" x 20' x 12" Garage-in-a-Box SUV/Truck® Parts List - Model #62693

Description of Parts:	Quantity	Part #
 Rafter Poles, Swedged	12	802346
 Rafter Poles, not Swedged	12	802340
 Upright Poles	12	802636
 Upright Extension Poles	8	802347
 Upright Extension Corner	4	802348
 Cross Rail, Swedged	20	802129
 Cross Rail, not Swedged	5	802130
 Sliding Cross Rail	10	10110
 Wind Brace, one end Swedged	4	802344
 Wind Brace, plain end	4	802345
 Top Bend	6	802341
 Side Bend	12	802343
 Foot Bend	4	802637
 Steel Foot Plate	8	802342
 ShelterLock™	24	800597
 Ratchet Clamp	8	10040
 Plastic Bolt Cap <i>(for 802497 bolt)</i>	12	10150
 Carriage Bolts 1/4" x 3 3/8"	24	802497
 Round Head Bolts 1/4" x 3"	6	802630
 Bolts 1/4" x 1 1/2"	4	03025
 Bolts 1/4" x 1 5/8"	56	10115
 Bolts 1/4" x 1 3/4"	8	03034
 Bolts 1/4" x 1 7/8"	36	03032
 Washer 1/4"	20	01011
 Nut 1/4"	134	01010
 4-way Cover Rail Half-Clamps for Middle Legs	16	13201
 3-Way Cover Rail Half-Clamps for Corner Legs	8	13202
 Cover	1	802337
 2-Zipper Door	1	802339
 Back Panel	1	802338
 15" Auger Anchors (Temporary)	6	00847
 Cable Clamps	6	10016
 Lengths of Cable	6	10015
 RollUp Door Kit (boxed separately)	1	10077

1. LAY OUT ROOF FRAME

REAR

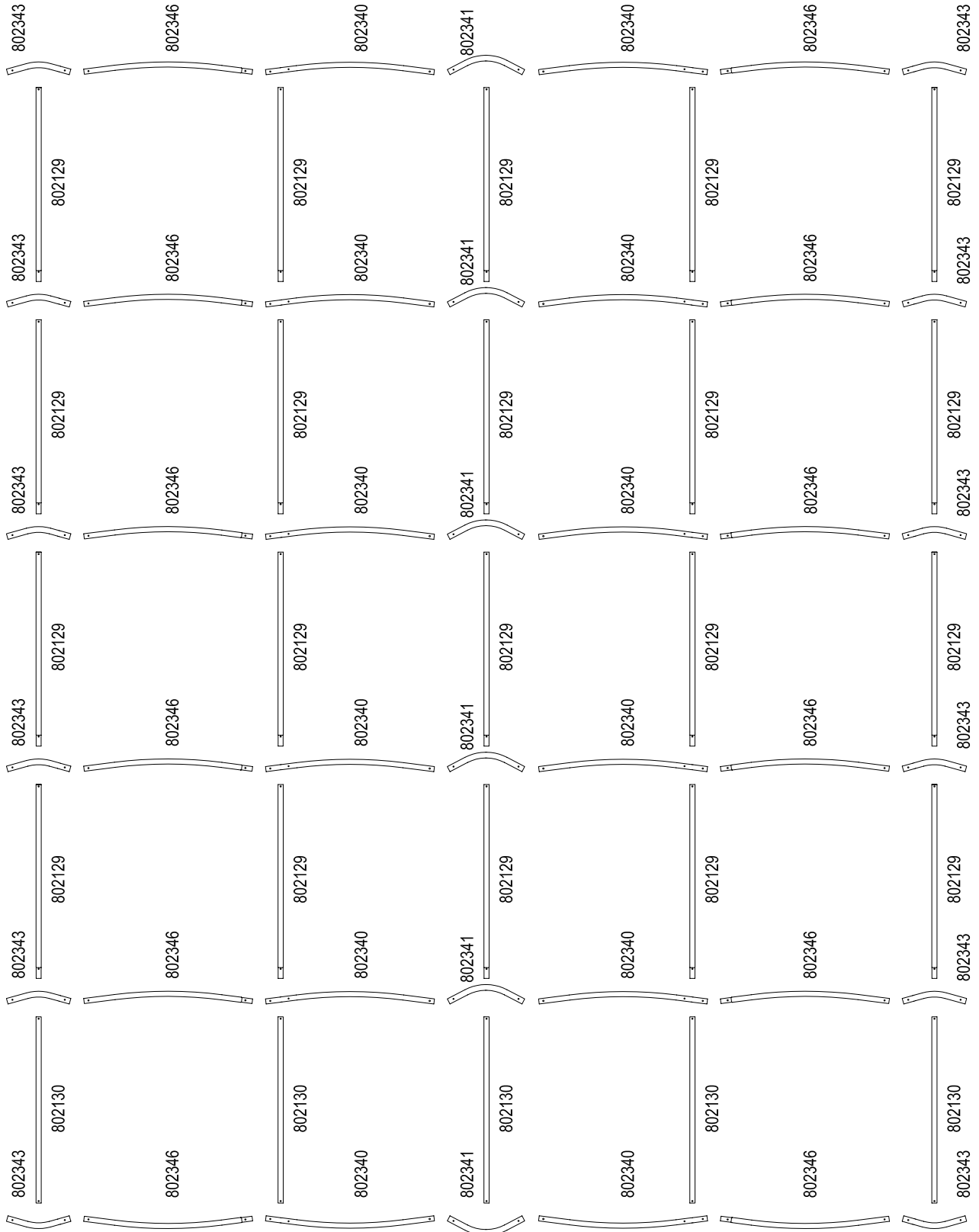

FRONT

2. ASSEMBLE ROOF FRAME Use bolts as shown in illustrations.

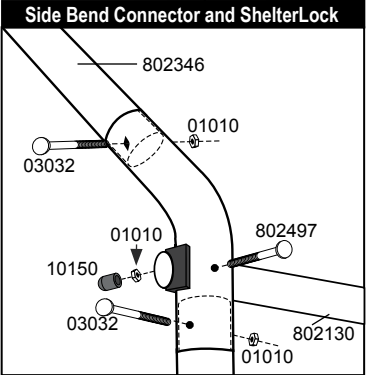
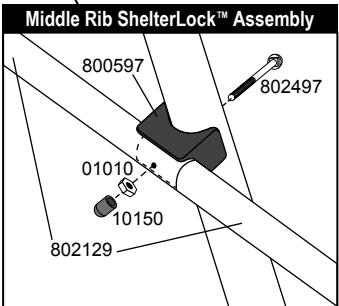
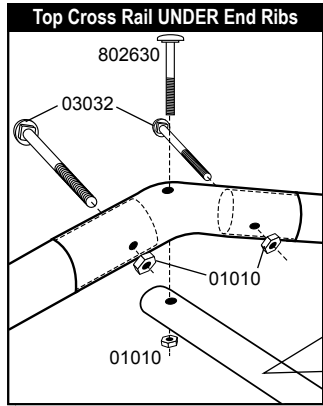
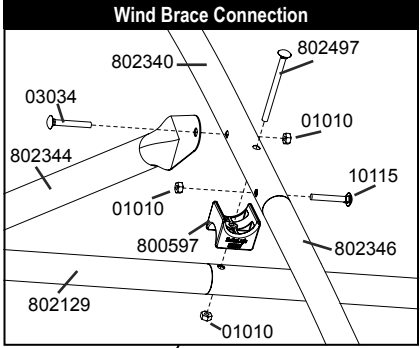
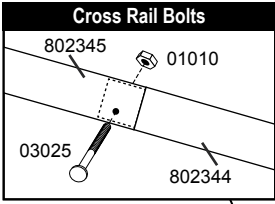
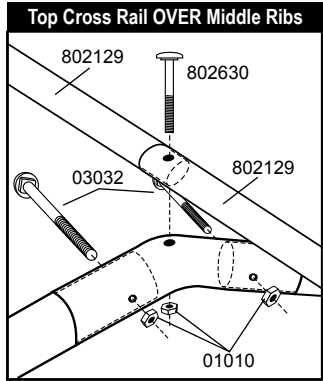
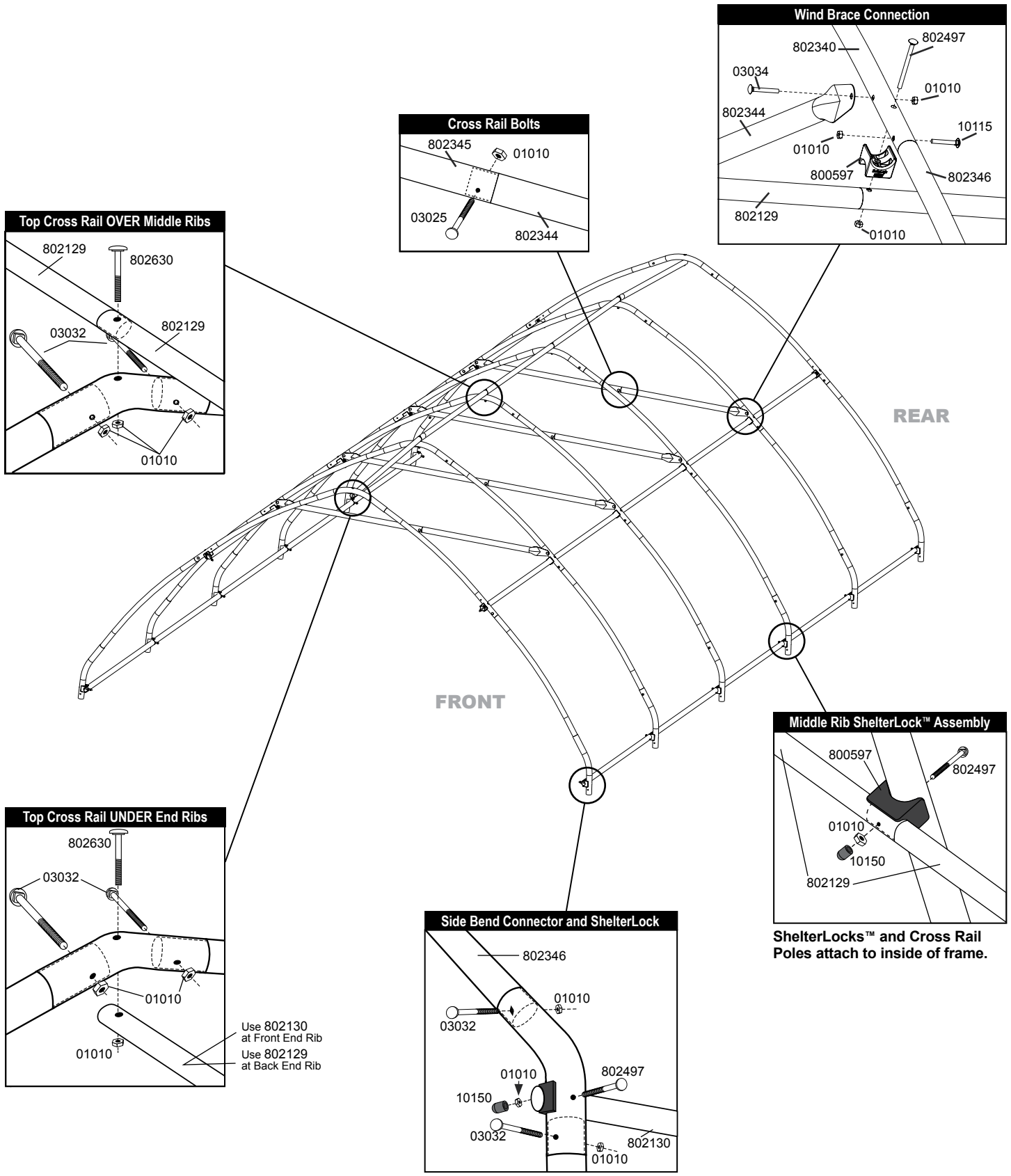

ShelterLocks™ and Cross Rail Poles attach to inside of frame.

3. ASSEMBLE LEGS & ATTACH TO ROOF FRAME *Use bolts as shown in illustrations.*

- A. Assemble Corner and Middle legs.
- B. Attach legs with bolts on one side of roof frame, let the other side of roof frame rest on the ground.
- C. Attach remaining legs with bolts to opposite side of roof frame.

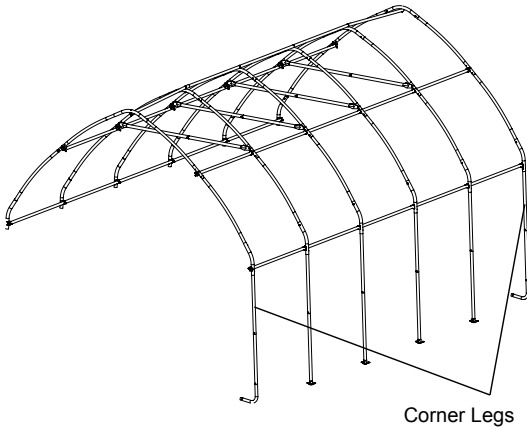
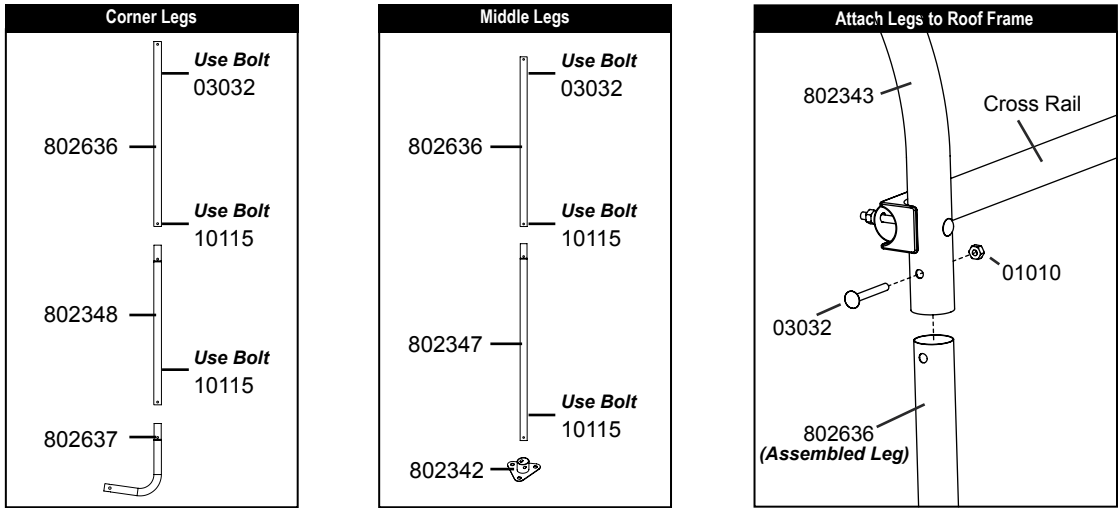

Corner Legs

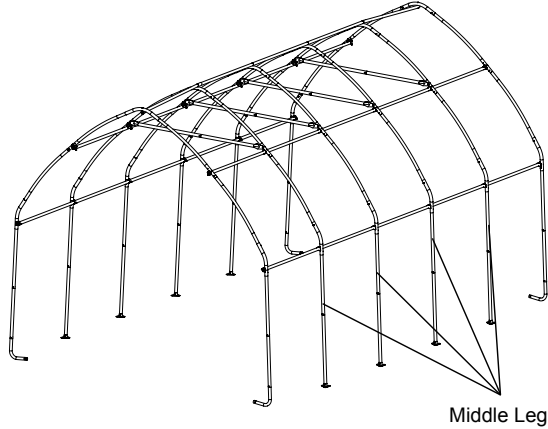

Middle Legs

4. ASSEMBLE COVER RAILS

- A. Place the cover rail (10110) at each leg and secure it at each leg with a cover clamp as shown below.
- B. Slide the cover rails so they are 8" up from the ground and **hand tighten bolts on clamps.**

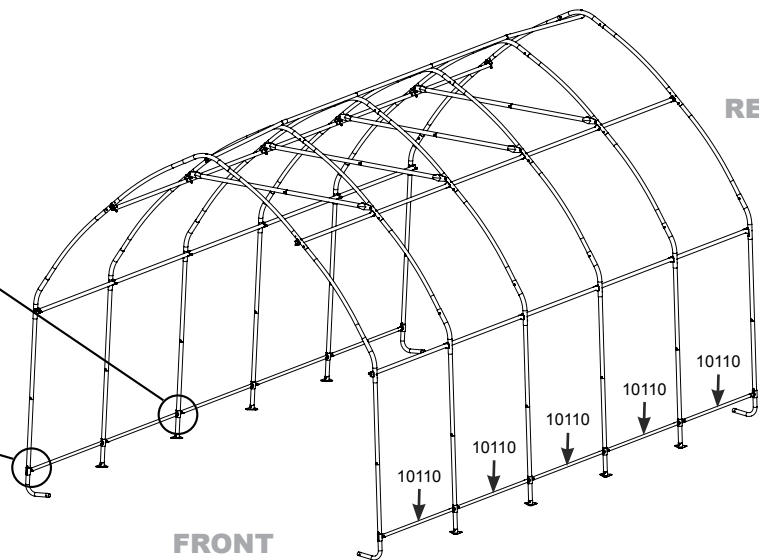
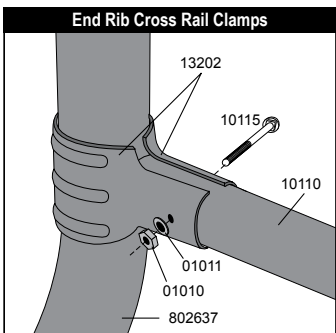
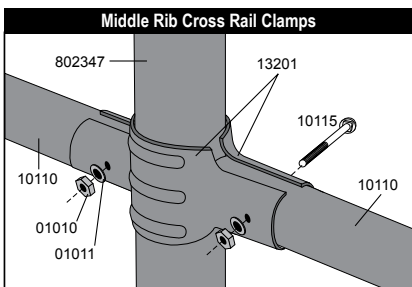

REAR

FRONT

5. SQUARING UP THE FRAME

- A. Place frame in its final location, which needs to be as flat and level as possible.
- B. Measure across opposite corners. **These distances must be equal to within 1".**
- C. Check that the front and rear of the frame measures 13' 2" in width.

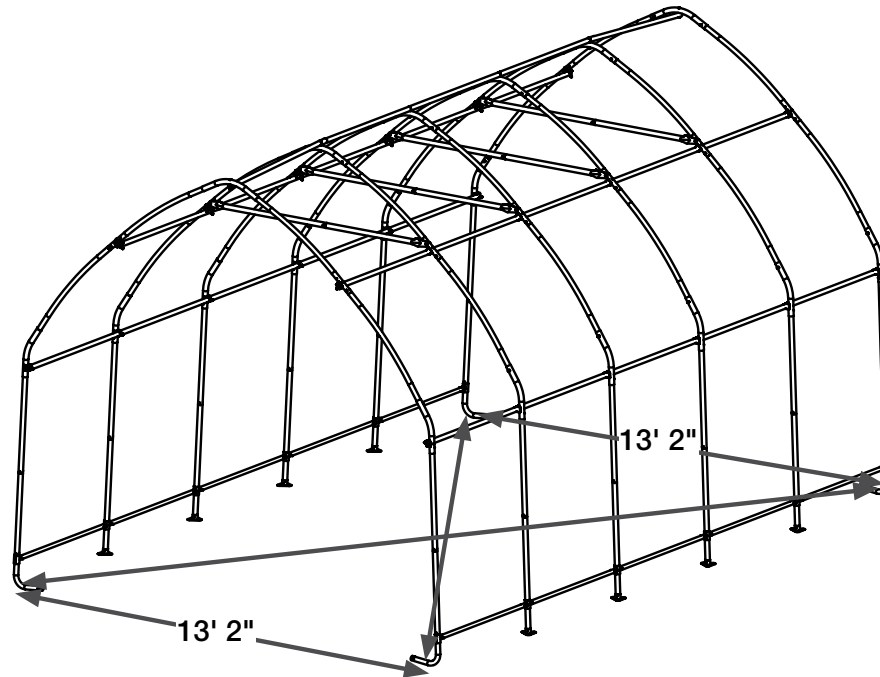

6. PROPERLY ANCHOR THE FRAME

- A. Anchors must be placed inside shelter at the corners of the shelter.
- B. Insert a 3/4" pipe or steel rod, through the eyelet of the auger and screw the anchor into the ground until the eyelet is sticking out of the ground by 1-2" so it can be anchored to the legs.
If ground is too hard, dig a hole with a shovel or post hole tool. Optional: Fill with cement.
- C. Wrap cable provided through the eyelet of the anchor and around the frame as shown below. Secure the cable with the clamps provided.

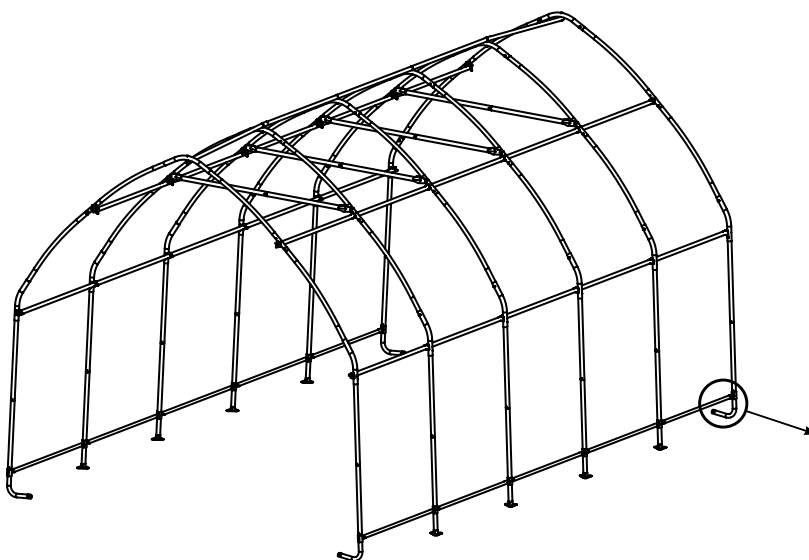

NOTE:

15" Augers are for temporary use only!
For best results ShelterLogic recommends using our Easy Hooks (#10036 4-pack, #10035 6-pack, or #10038 8-pack) or 30" Augers (#10075 4-pack, #10078 6-pack, or #10079 8-pack) for a stronger, more secure installation.

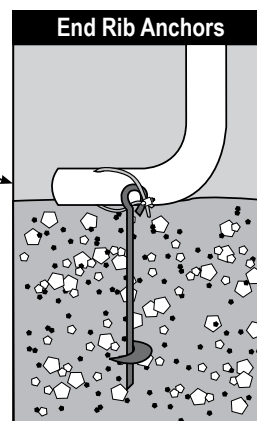

Call 1-800-524-9920
or visit
www.shelterlogic.com
for more information.

7. DOOR AND SOLID END PANEL INSTALLATION

- A. Hold end panel at the top center with white inner surface facing inside of the shelter. Wrap the edges of the fabric panel around the end rib.
- B. Disconnect top rail from the end rib. Pass the top cross rail through the gap in the fabric, in between the webbing and rib frame. Re-attach top cross rail to end rib. *Repeat Step B for side cross rails.*
- C. At the bottom, where the webbing exits the pocket on each side of end panel, pull webbing to remove the slack. **Be careful not to pull the webbing through the other side of the webbing pocket.**
- D. Insert the "S"- Hook on ratchet into hole on the leg bend. Insert the webbing into the spindle of the ratchet and pull tight. Wind the ratchet so that the webbing overlaps itself.

Position the end panel so that it is centered on the building before fully tightening the end panel.

- E. Tighten ratchets, alternating from one side to the other, until the end panel is centered and tight.

Zipper Door Panels: Zippers must be closed when tightening end panel.

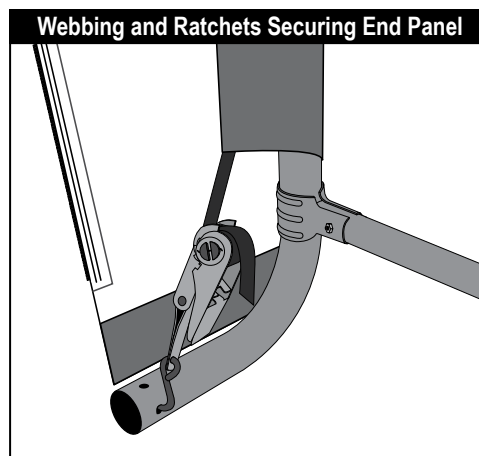
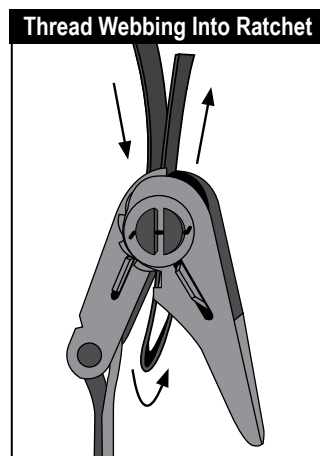
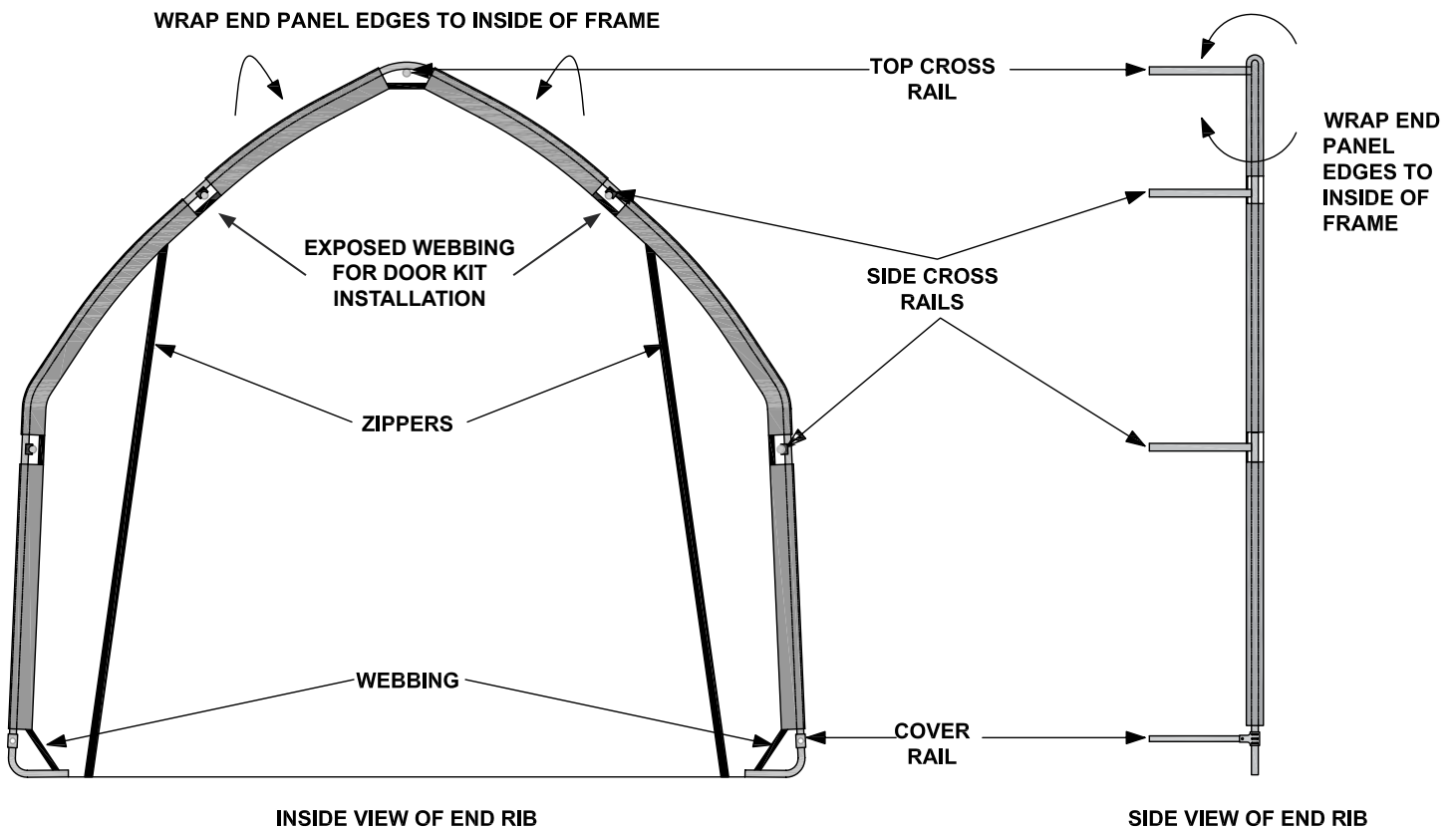

8. INSTALLING COVER AND COVER RAILS

- A. Lay the cover on the ground next to the frame with inside of the cover (the side with the pipe pockets) facing down and the webbing on the front and rear of the corner of the building. Make sure that the Grommets are facing the FRONT of the frame.
- B. Pull cover over the frame, making sure to center cover on frame. There should be an equal amount of overhang at all four corners.
- C. Insert the "S"- Hook on ratchet into hole on the leg bend. Insert the webbing into the spindle of the ratchet and pull tight. Wind the ratchet so that the webbing overlaps itself.
- D. Disassemble cover rails and slide through fabric pockets at each leg and reattach with clamps to each leg. Repeat this on other side. Push down on cover rails to tighten cover, before tightening bolts completely.
- E. Check and tighten Ratchets and Cover Rails monthly to ensure the cover is tight.

IMPORTANT NOTE: Your pre-packed Roll-Up Door Kit includes a manual that instructs you to cut holes for installation (Step F). The GIB SUV/Truck includes grommets in the cover especially for this Door Kit. DO NOT cut holes as instructed in Step F.

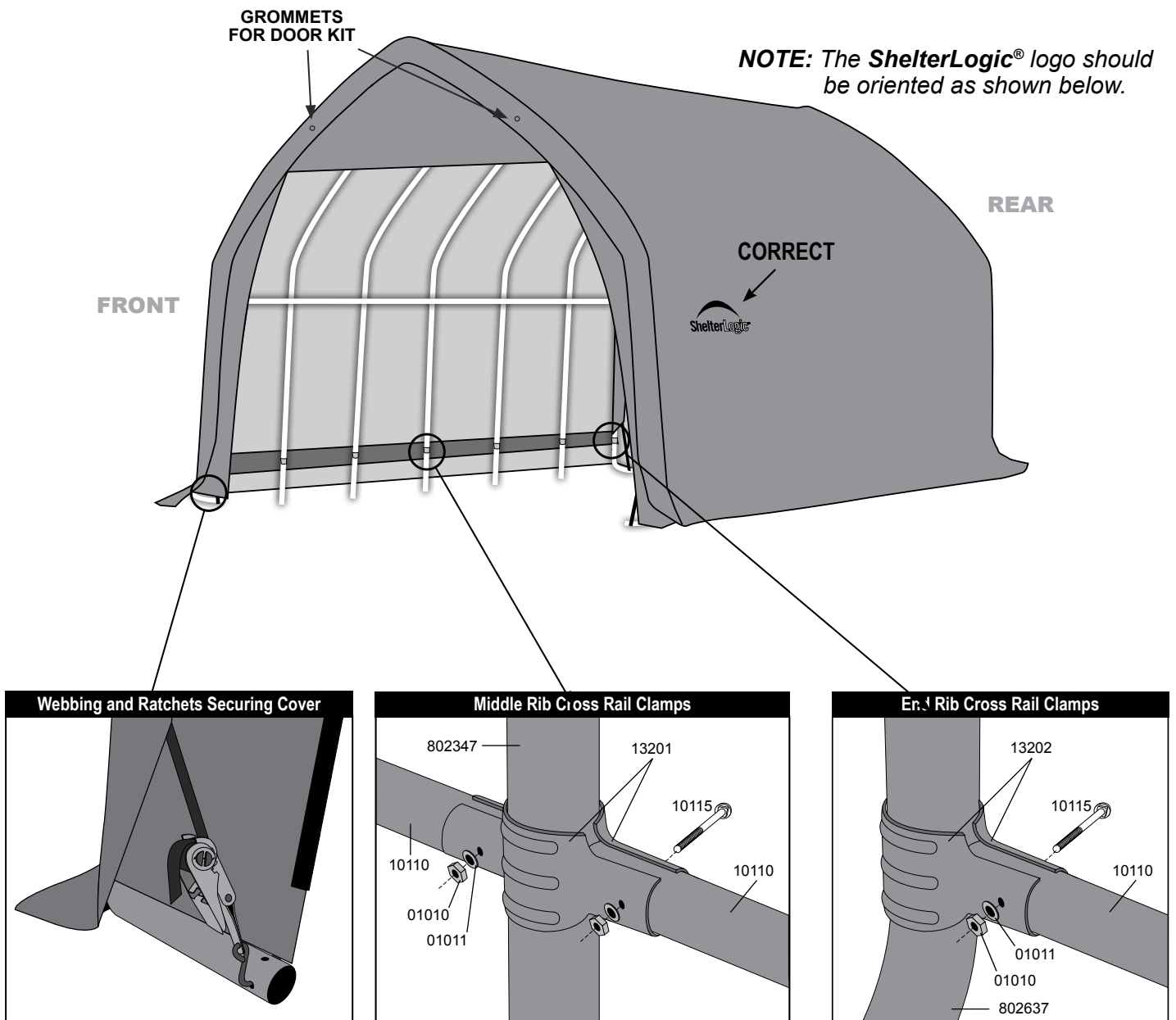

4 x 6,1 x 3,6 m Garage-in-a-Box SUV/Truck®

LES TRADUCTIONS FRANÇAISES D'INSTRUCTION D'ASSEMBLAGE

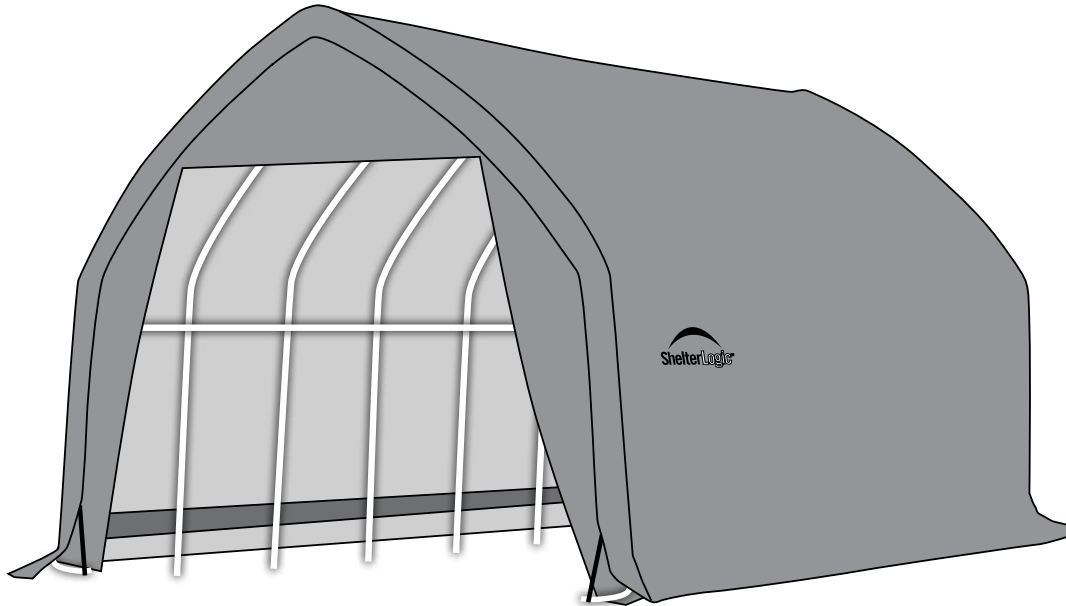

DESCRIPTION	MODÈLE N°
4 x 6,1 x 3,6m Garage-in-a-Box SUV/Truck® - Gris	62693

OUTILS RECOMMANDÉS

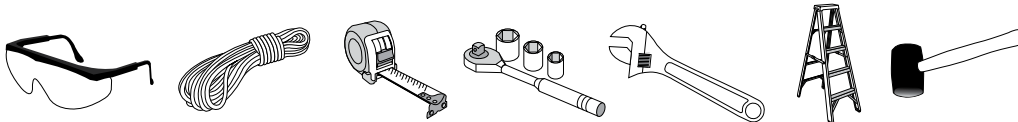

Lire **TOUTES** les instructions avant de monter. Cet abri **DOIT** être bien ancré.
Ceci est une structure temporaire, il n'est pas recommandé d'en faire une structure permanente.

Avant de commencer: Il faut 2 personnes ou plus pour le montage qui prend environ 2 heures.



150 Callender Road
Watertown, CT 06795
www.shelterlogic.com

1-800-524-9970

Canada:
1-800-559-6175

ATTENTION:

Ce produit Shelter est conçu avec des matériaux de la plus haute qualité. Il est conçu pour être utilisé avec la toile fabriquée par ShelterLogic. **ShelterLogic®**, LLC offre un abri et une protection contre les faits malfaisants du soleil, une pluie légère, la sève des arbres, les excréments animaliers et une légère tomber de neige. S'il vous plaît ancrez la structure **ShelterLogic®**, LLC d'une manière correcte. Un ancrage correcte, garder la toile bien tendue et sans accumulation de neige et sans débris est la responsabilité du consommateur. Prenez bien soin de lire et de comprendre les détails de l'installation, les remarques et avertissements avant l'installation finale du produit. Si vous avez des questions appeler le service clientèle afficher sur la première page de votre manuel d'installation. Aussi référencez-vous à la carte de garantie fournie avec votre achat.

DANGER:

Choisissez avec soin l'emplacement de l'abri. **Danger: Installez à distance de fils électrique.** Faites attention aux lignes à haute tension, branches d'arbre et autre structure. NE PAS installer près de toits, ou tout autres structures des quels de la neige, glace, ou eau excessive pourrait tomber sur l'abri. Ne pas pendre d'objet sur labri.



ATTENTION:

Risque de feu. NE PAS fumer ou utiliser des outils à flamme ouverte (barbecue, friteuse, fumeurs ou lanternes) dans ou aux alentours de l'abri. NE PAS stocker de liquide inflammable (gazoline, kérosène, propane, etc.) dans ou aux alentours de votre abri. N'exposer pas le toit ou les cotes à une flamme ouverte ou toute autre source de feu.

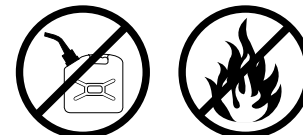

AVERTISSEMENT:

Soyez très prudent pendant la construction de la charpente. Utilisez des lunettes de protection pendant la durée de l'installation. Sécurisez et boulonnez ensemble tout les tubes de la toiture pendant l'assemblage. Attention au bout des tuyaux.

MISE EN GARDE:

L'ANCRAGE CORRECT DE LA PORTE AUTOMATIQUE EST LA RESPONSABILITÉ DU CONSOMMATEUR.

ShelterLogic®, LLC n'est pas responsable pour tout dommage à l'unité. Toute porte automatique qui n'est pas ancrée correctement et de façon sécuriser a le potentiel d'être endommager, et ne sera pas couvert sous la garantie. Vérifier les ancrés et la charpente de façon périodique pour s'assurer de la stabilité. **REMARQUE:** *La couverture de votre abri peut être rapidement enlevé et stocker avant des conditions météorologiques sévères. Si des vents forts ou des conditions sévères sont annoncées, nous recommandons d'enlever la couverture.*

PIÈCES DE REMPLACEMENT. ASSEMBLAGE. COMMANDES SPÉCIALES:

Des pièces de rechange **ShelterLogic®**, LLC et accessoires sont disponible direct de l'usine, inclus sont des kits d'ancrages, couverture de rechange, panneau et kit d'enclosure, kit de lumière et de ventilation, tube de charpente, portes à glissières et autres accessoires. Tous sont envoyés direct de l'usine à votre domicile.

QUESTIONS – RÉCLAMATIONS – COMMANDES SPÉCIALES? APPELER NOTRE SERVICE CLIENTÈLE:

SERVICE CLIENTÈLE US: 1-800-524-9970 SERVICE CLIENTÈLE INTERNATIONAL: 001-860-945-6442 SERVICE CLIENTÈLE CANADIEN: 1-800-559-6175

HEURES D'OPÉRATIONS: LUNDI – VENDREDI: 8:30AM – 8:00PM EST, SAMEDI – DIMANCHE: 8:30AM – 5:00PM EST.

ENTRETIEN ET NETTOYAGE:

Une couverture bien tendue assurera une vie plus longue et de meilleur performances. Toujours maintenir la couverture bien tendue. Une couverture mal tendue peut accélérer la détérioration de la couverture. Enlever du toit toute accumulation de neige ou de glace immédiatement avec l'aide d'un balai, d'un balai serpillère ou autre instrument à bord doux. Garder le raille propre et sans débris. NE PAS utiliser d'eau de javèle ou autre produits nettoyant abrasive pour nettoyer la couverture. Le panneau de porte peut être facilement nettoyé avec de l'eau et du savon. NE PAS utiliser des outils a bord coupant, ou des instruments comme râteau ou pelle pour enlever la neige. Cela pourrait trouer la couverture. N'utiliser pas d'eau sous haute pression.

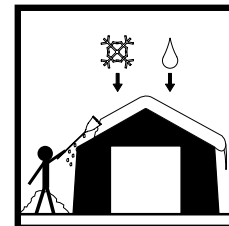











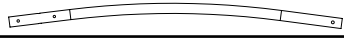
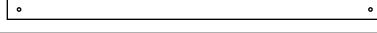
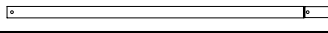

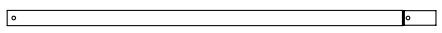
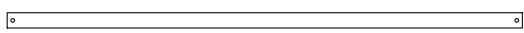

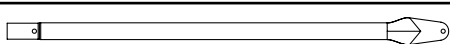
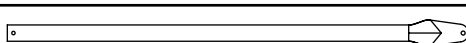

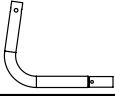



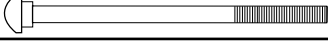



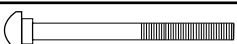

GARANTIE:

Comprend une garantie limitée contre les défauts de fabrication. **ShelterLogic®**, LLC garantie aux propriétaires que si utiliser et installer de façon correcte, le produit et toutes pièces associer, seront sans défauts de fabrication pour une période de:

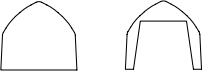
1 AN POUR LA COUVERTURE, LES PANNEAUX AVANT ET ARRIERE ET LA CHARPENTE.

La période de garantie est déterminer par la date d'envoi de l'usine de **ShelterLogic®**, LLC, pour les commandes directes, ou par la date d'achat d'un distributeur autoriser à la vente. (S'il vous plaît conserver la copie de votre reçu d'achat). Si ce produit ou toutes pièces associées sont défectueuses ou manquantes au moment de la réception, **ShelterLogic®**, LLC réparera ou remplacera, à sa discrétion, les pièces défectueuses sans frais au consommateur. Les pièces de remplacement ou pièces réparées seront couvertes pour le reste de la garantie original limitée. Tout frais de port sera la responsabilité du consommateur. Pièces et remplacements seront envoyés en COD. Vous devez conserver l'emballage original pour les renvois. Si vous acheter dans un distributeur local, toutes réclamations doivent être accompagné du reçu d'achat. Après l'achat, remplissez et renvoyez la carte de garantie pour enregistrer le produit. Voir carte de garantie pour plus de détails.

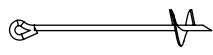
4 x 6,1 x 3,6m Garage-in-a-Box SUV/Truck® Les Parties Énumèrent - Modèle n° 62693

Description des Produits:		Quantité	Partie #
	Tubes de toiture, bout fin	12	802346
	Tubes de toiture, bout normal	12	802340
	Tube verticale 83,8 cm (33 po)	12	802636
	Tubes d'extension vertical	8	802347
	Coins d'extension vertical	4	802348
	Rails transversaux, Swedge	20	802129
	Rails transversaux, sans Swedge	5	802130
	Tube de couverture	10	10110
	Support contre vent, serrer sur un bout	4	802344
	Support contre vent, bouts normaux	4	802345
	Courbure supérieure	6	802341
	Courbure Lateral	12	802343
	Pied Courbé	4	802637
	La Plaque En Acier de Pied	8	802342
	ShelterLock™ Bloque Stabilisateur	24	800597
	Cliquet	8	10040
	Chapeau à boulon (Pour boulou 802497)	12	10150
	Boulons de 6,4 x 85,7 mm (1/4 x 3 3/8 po)	24	802497
	Boulou à tête arrondie 6,4 x 76,2 mm (1/4 x 3 po)	6	802630
	Boulons de 6,4 x 38,1 mm (1/4 x 1-1/2 po)	4	03025
	Boulons de 6,4 x 41,2 mm (1/4 x 1-5/8 po)	56	10115
	Boulons de 6,4 x 44,4 mm (1/4 x 1-3/4 po)	8	03034
	Boulons de 6,4 x 47,6 mm (1/4 x 1-7/8 po)	36	03032
	Joint de 6,4 mm (1/4 po)	20	01011
	Écrous de 6,4 mm (1/4 po)	134	01010
	Demi-pinces pour pieds du milieu	16	13201
	Demi-pinces pour pieds du coin	8	13202
	Couverture	1	802337
	Porte avec 2 fermetures à glissière	1	802339
	Panneau arrière (solide)	1	802338
	Ancre Vrilles (Provisoire) 38,1 cm (15 po)	6	00847
	Câble - Longueur 30 cm (12 po)	6	10016
	Pinces de câble	6	10015
	Kit de roulement de porte (boite séparée)	1	10077

1. ÉTALER LA CHARPENTE DU TOIT

ARRIÈRE

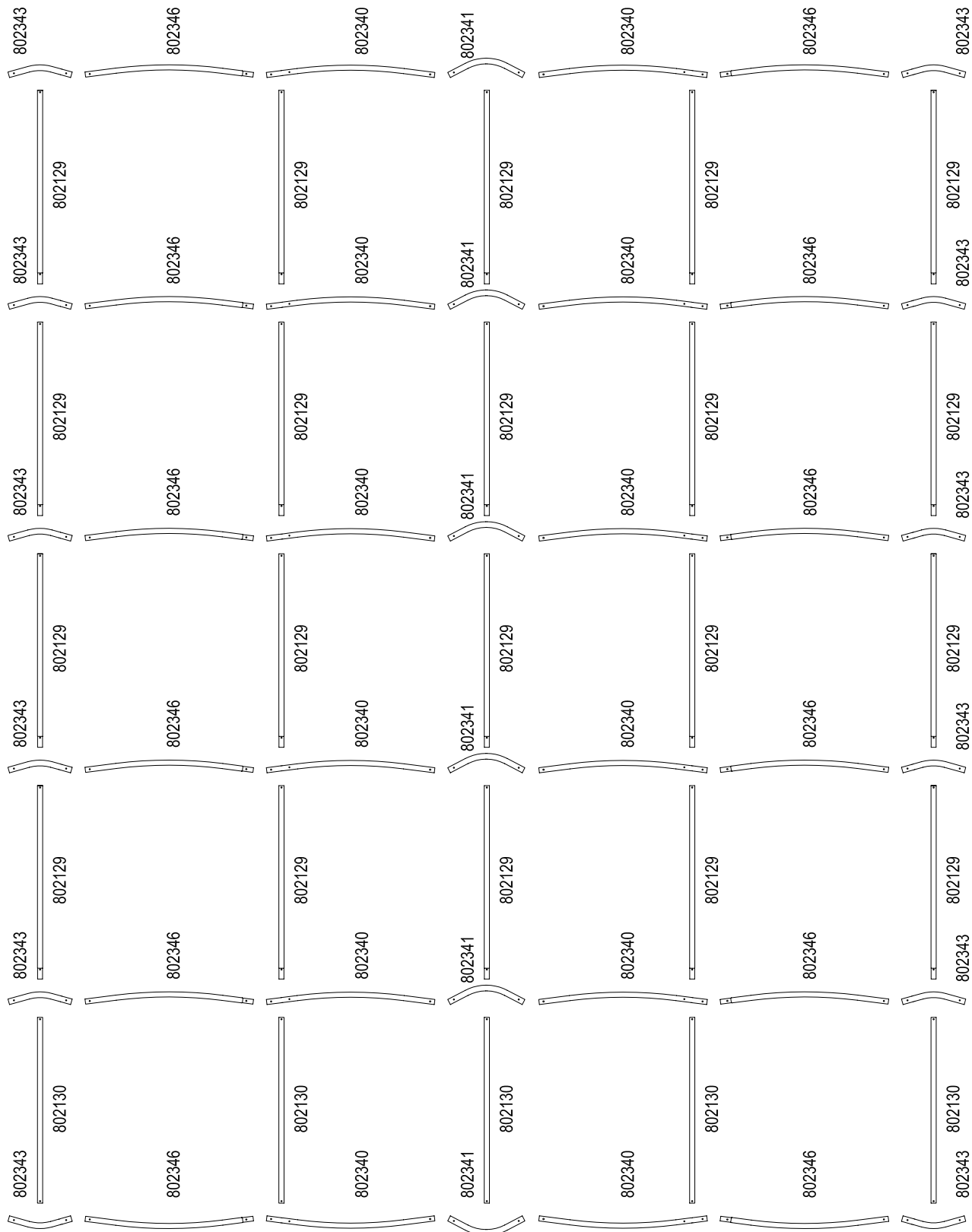

DEVANT

2. ASSEMBLAGE DU TOIT *Utilisez les boulons comme illustré.*

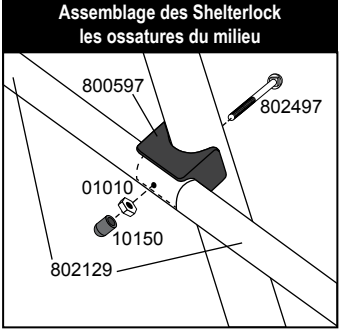
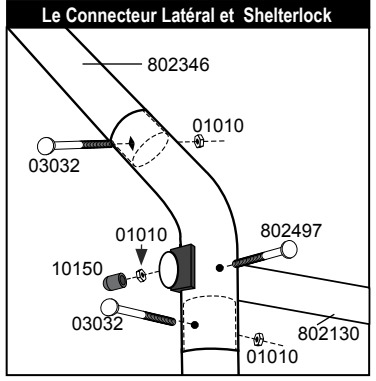
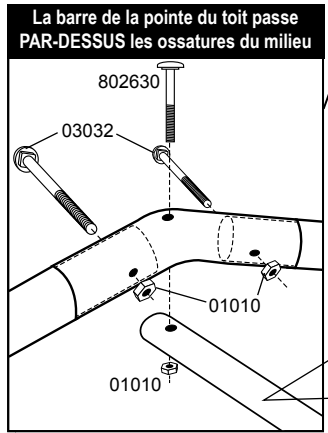
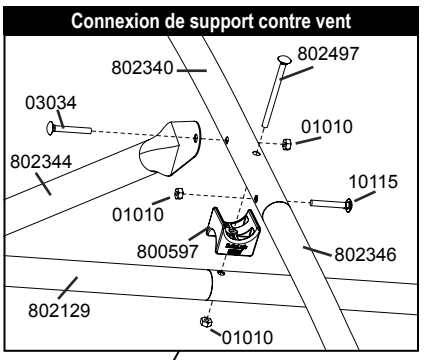
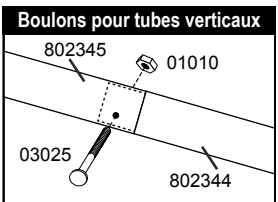
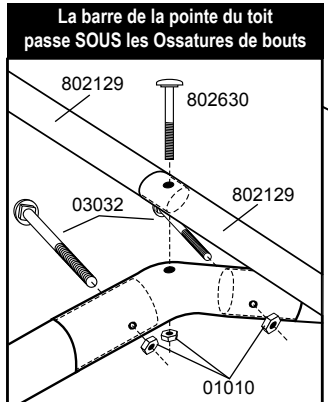
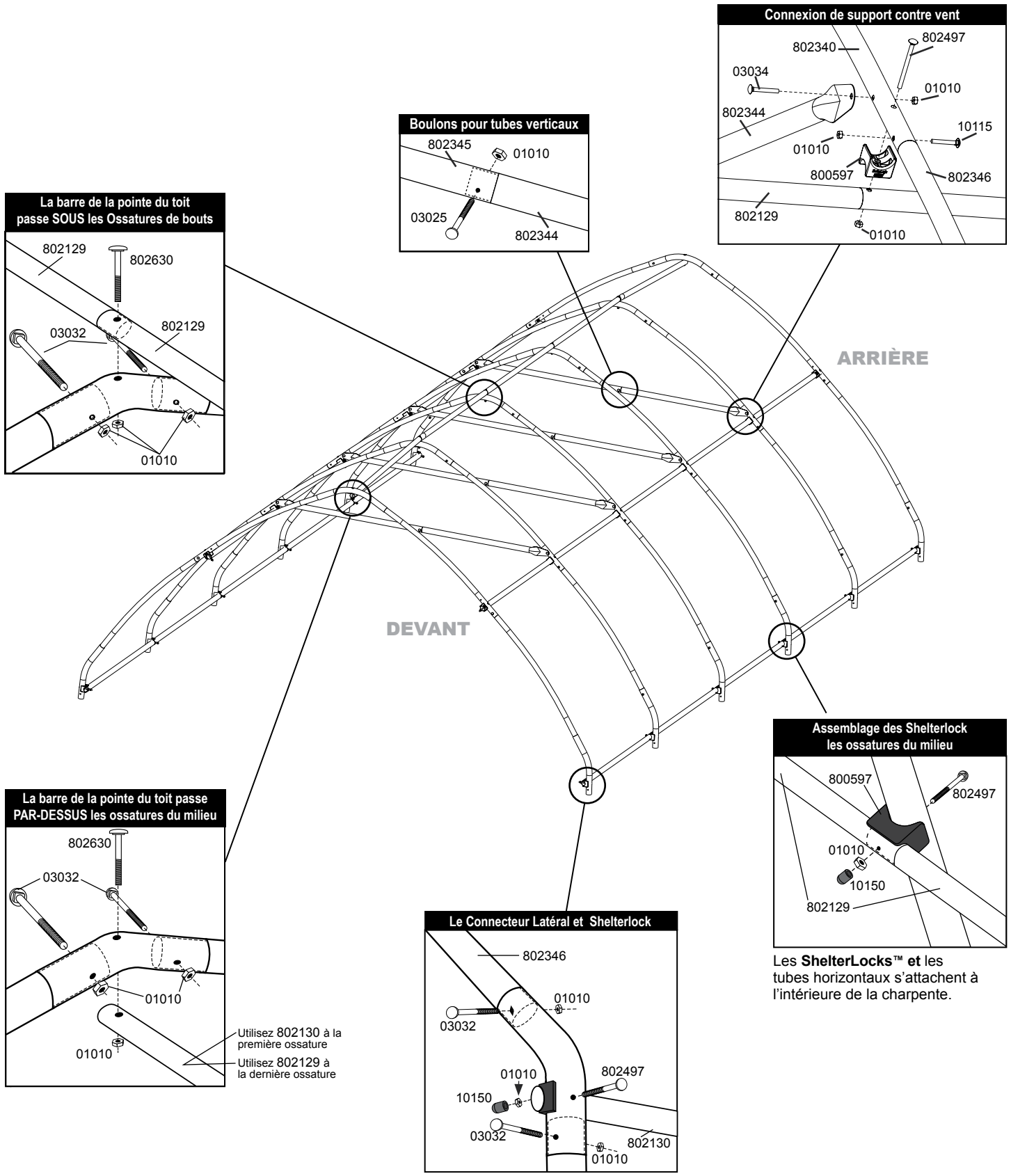

Utilisez 802130 à la première ossature
Utilisez 802129 à la dernière ossature

Les ShelterLocks™ et les tubes horizontaux s'attachent à l'intérieur de la charpente.

3. ASSEMBLER LES JAMBES ET ATTACHEZ LES AU TOIT *Utilisez les boulons comme illustré.*

- A. Assembler les jambes du milieu et les jambes des coins.
- B. Attachez les jambes avec les boulons sur un des coté de la toiture.
- C. Attachez le reste des jambes avec les boulons de l'autre coté de la toiture.

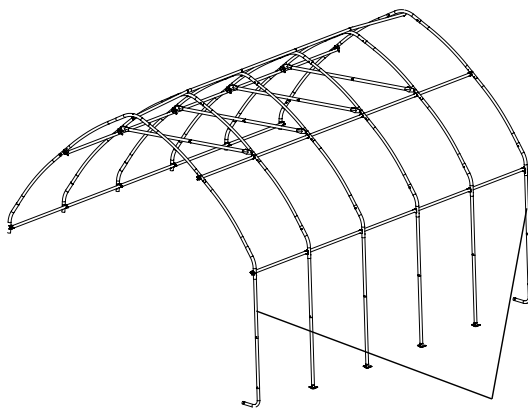
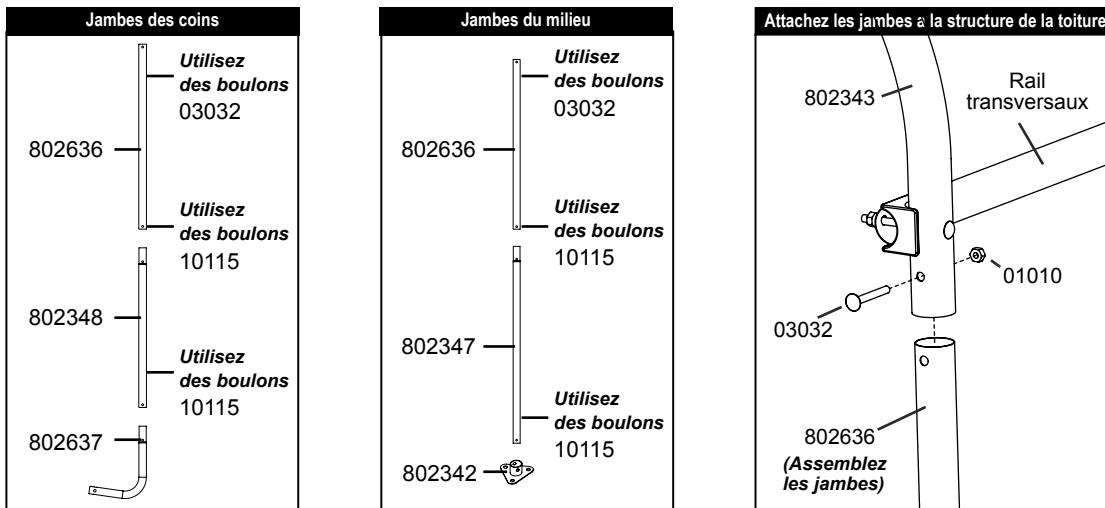

Jambes des coins

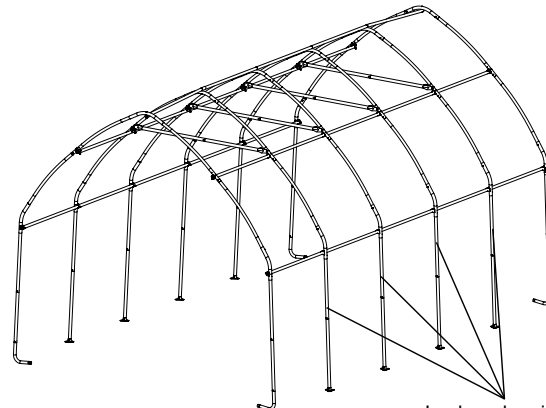

Jambes du milieu

4. ASSEMBLEZ LES TUBES DE COUVERTURE

- A. Positionnez les tube de couverture (10110) à chaque jambe, et attachez les avec les pinces comme montré.
- B. Glisser les tubes de façon à ce qu'ils soient à 20,3 cm (8 pouces) du sol, et serez les boulons à la main.

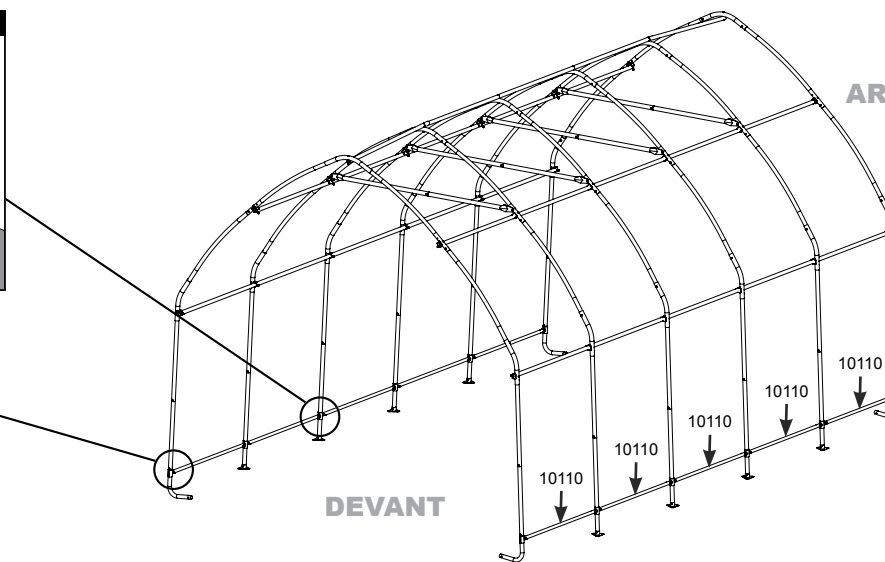
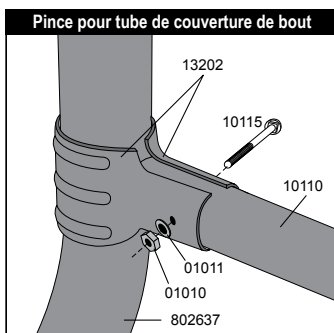
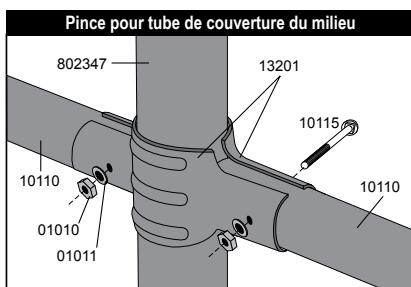

5. POSITIONNEZ LA CHARPENTE DE FAÇON RECTANGULAIRE

- A. Posez la charpente sur sa location finale, qui devrait être à niveau, et le plus plat possible.
- B. Mesurez à chaque coin opposés. Les distances devraient être les mêmes à 2,5 cm (un pouce) près.
- C. Vérifier qu'elle face 4 m / 13' 2" en largeur.

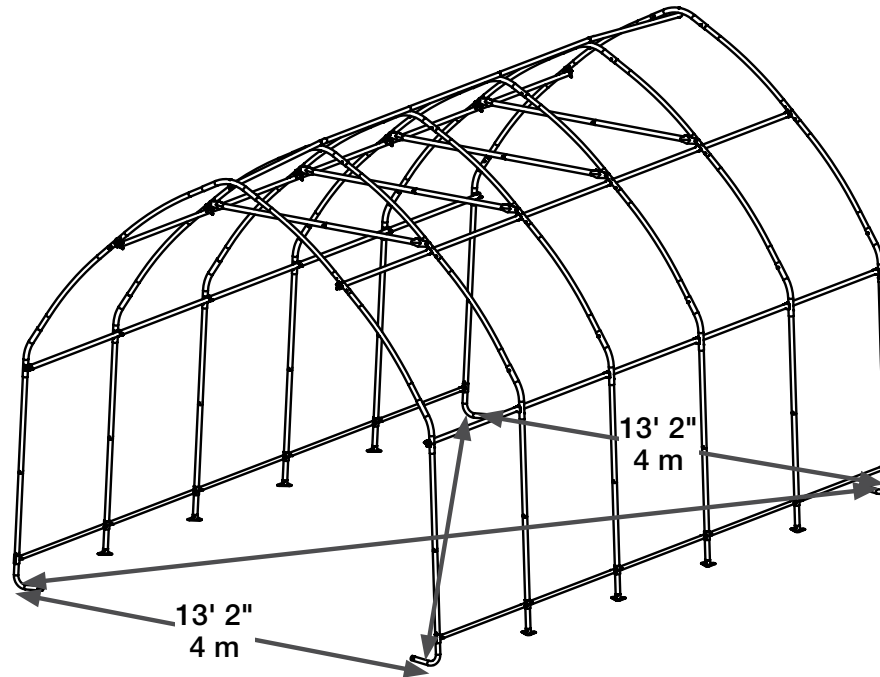

6. ANCREZ LA CHARPENTE DE FAÇON CORRECTE

- A. Chaque ancre doit être placée à l'intérieur de l'abri.
- B. Aux coins de l'abri, insérer un tube de 3/4", ou une barre en métal de la même taille, au travers de l'œillet de l'ancre et visser l'ancre dans le sol.
Si le sol est trop dur, creuser un trou avec une pèle ou une pioche. OPTIONNEL: Remplissez le trou de béton.
- C. Entourez le câble fournis dans l'œillet de l'ancre et autour de la charpente comme indiqué dans la illustration Sécurisez le câble avec la pince fournie.

REMARQUE:

Les ancres foreuses de 15" sont pour utilisation temporaire uniquement!
Pour de meilleurs résultats, Shelterlogic recommande l'utilisation de nos

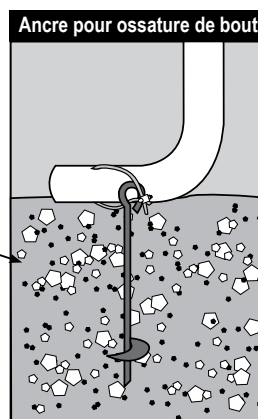
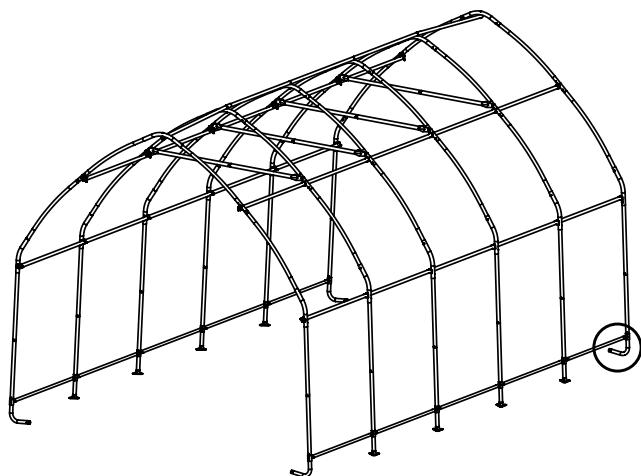

ancres "Easy Hooks" (#10036 paquet de 4, #10035 paquet de 6 ou #10038 paquet de 8) ou ancres foreuses de 30" (#10075 paquet de 4, #10078 paquet de 6 ou #10079 paquet de 8), pour une installation plus solide et sécurisée.

Appeler le 1-800-524-9920 ou visitez www.shelterlogic.com pour plus d'information.

7. INSTALLATION DES PANNEAUX DE PORTE ET DE BOUT

- A. Tenez le panneau en haut et au centre avec la partie blanche vers l'intérieur de l'abri. Entourez le bord de la toile autour de l'ossature et passez les tubes au travers de la fente déjà coupée dans la toile.
- B. Déconnectez le tube a la point du toit de l'ossature. Ce tube doit passer au travers de l'espace de la toile, et doit être entre la sangle et l'ossature. Répétez l'étape B pour les tubes latéraux.
- C. En bas, la ou la sangle sort de la poche de chaque coté du panneau, tirez sur la sangle pour tendre le panneau. **Faites bien attention de ne pas trop tirer sur la sangle pour éviter qu'elle disparaisse de l'autre coté du panneau.**
- D. Insérez le crochet en "S" dans le trou du coin courbé de la jambe. Insérez la sangle dans le cliquet et tirez fort. Remontez le cliquet jusqu'à ce que la sangle s'enroule autour d'elle-même. **Positionnez le panneau de manière à ce qu'il soit bien centré sur l'abri.**
- E. Serrez les cliquets, en alternant d'un coté à l'autre, jusqu'à ce que le panneau soit bien tendu.

Panneau à glissières: Les glissières doivent être fermées l'hors de l'installation.

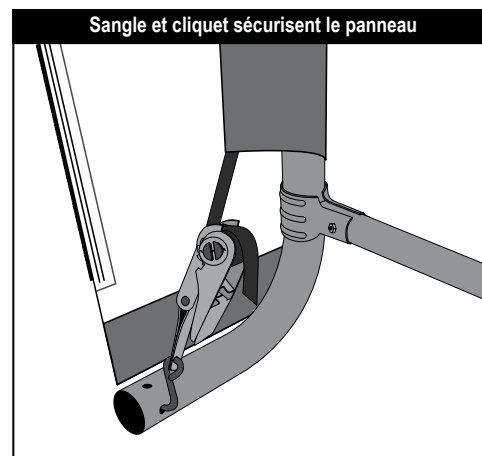
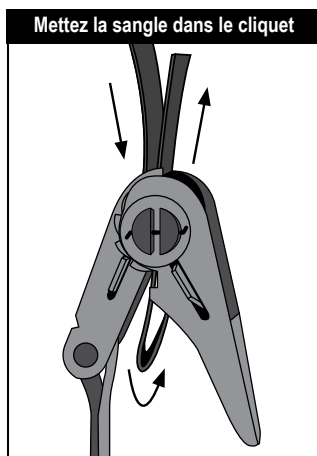
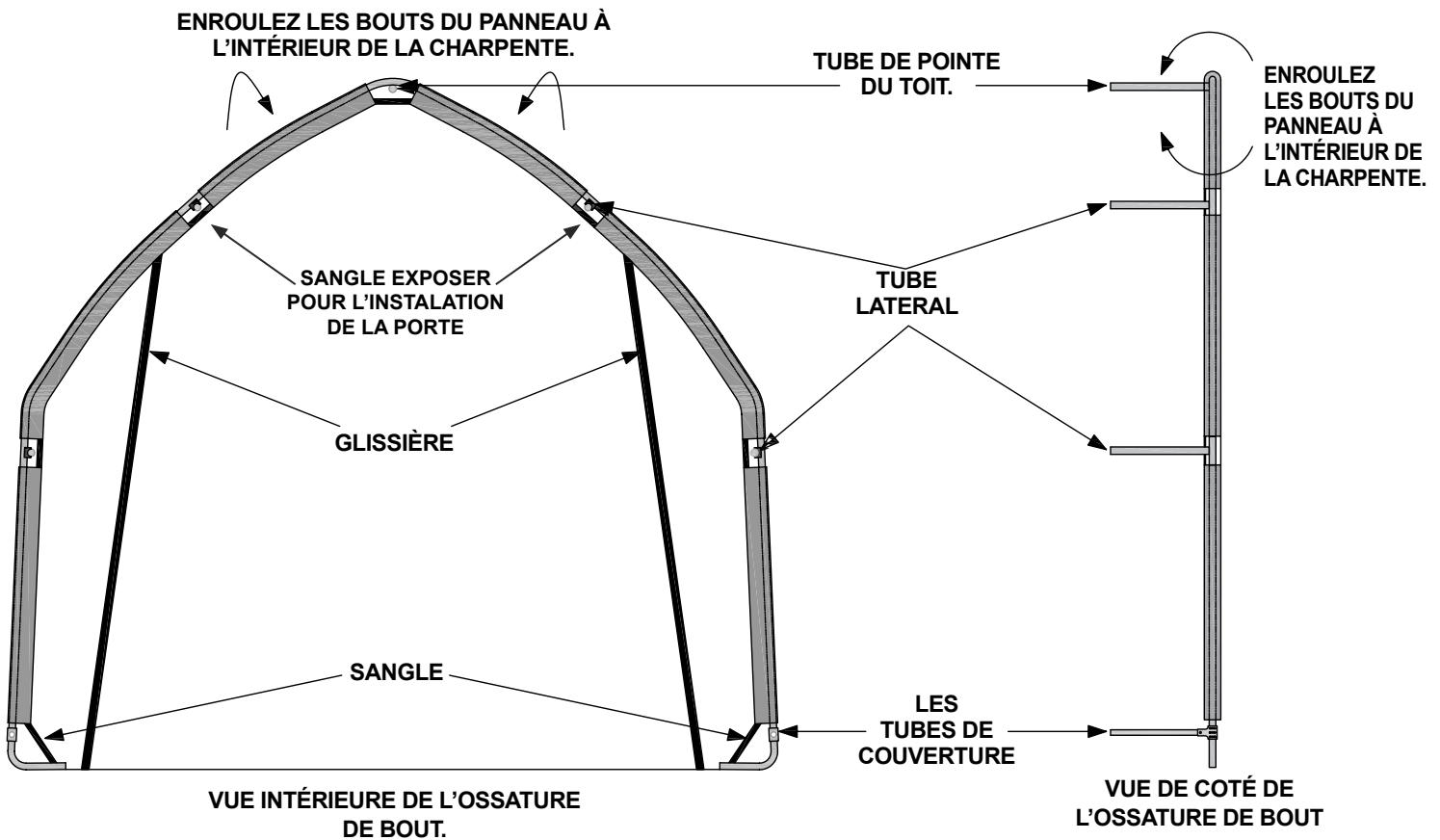

8. INSTALLER LA COUVERTURE PRINCIPALE AINSI QUE LES TUBES DE COUVERTURE

- Étalez la couverture à côté de la charpente avec le côté avec les poches vers le sol, et les sangles près des coins avant et arrière de l'abri.
- Tirez la couverture par-dessus l'abri. Le rebord devrait être égale aux 4 coins.
- Insérez le crochet en "S" dans le trou du coin courbé de la jambe. Insérez la sangle dans le cliquet et tirez fort. Remontez le cliquet jusqu'à ce que la sangle s'enroule autour d'elle-même.
- Détachez les tubes de couverture et glissez les dans les poches à chaque jambes, et ré-attachez les tubes avec les pinces. Répéter cela de l'autre côté. Appuyer sur les tubes de couvertures afin de bien tendre la couverture avant de bien serrer les boulons des pinces.
- Vérifiez et resserrez les cliquets ainsi que les tubes de couverture de façon mensuelle pour s'assurer que la couverture soit bien tendue.

REMARQUE IMPORTANTE: Votre kit de roulement de porte inclut un manuel d'instruction qui vous demande de couper des trous pour l'installation (étape F). Le GIB SUV/Camion inclut des œillets dans la couverture conçus spécialement pour ce kit de roulement de porte. **NE PAS couper de trous comme demander dans l'étape F.**

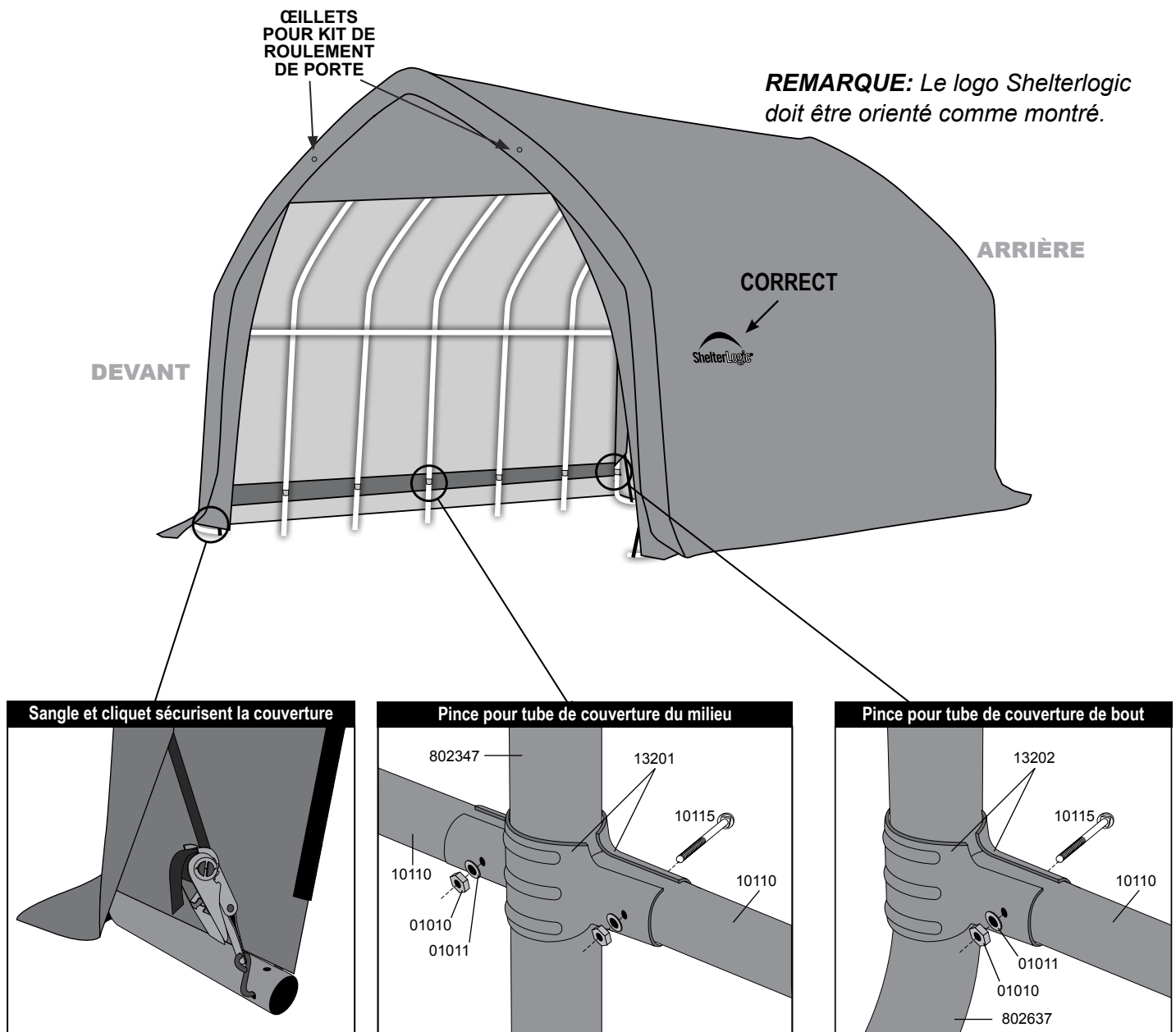

4 x 6,1 x 3,6 m Garage-in-a-Box SUV/Truck®

INSTRUCCIONES DE ENSAMBLAJE EN ESPAÑOL

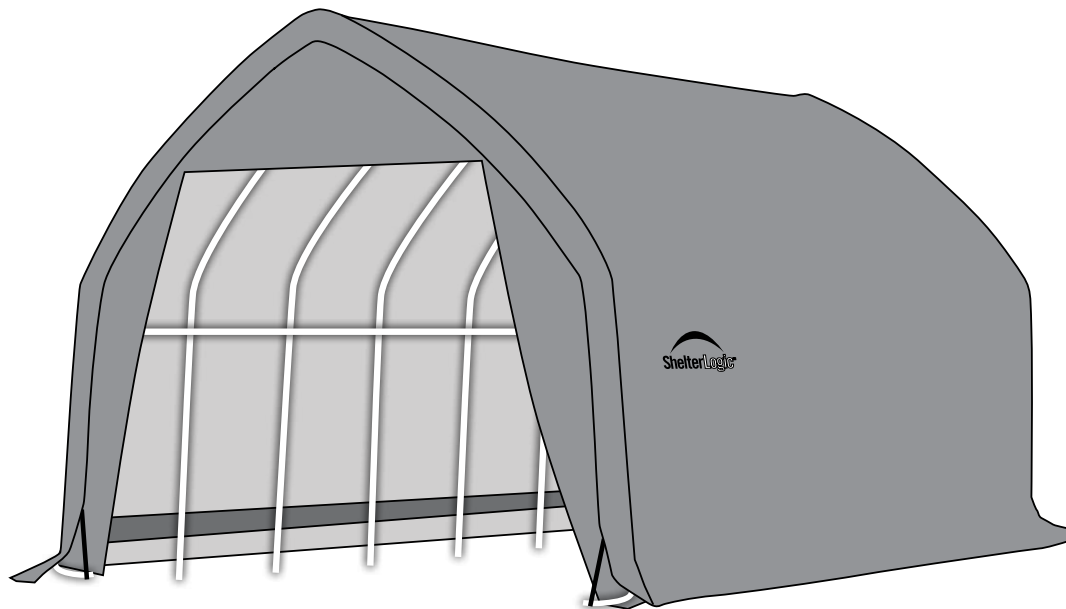

DESCRIPCIÓN	MODELO N°
4 x 6,1 x 3,6m Garage-in-a-Box SUV/Truck® - Gris	62690

HERRAMIENTAS RECOMENDADAS

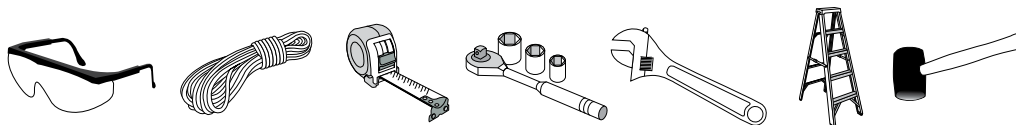

Por favor lea las instrucciones **COMPLETAMENTE** antes de ensamblar. Este cobertizo **DEBERÁ** anclarse de forma segura. Verifique tubos más grande interiores de diámetro para tubos más pequeños. No **VUELVA** el PRODUCTO A LA TIENDA. Las Partes perdidas, Ayuda de Reemplazo o Asamblea, LLAMA el Servicio de atención al cliente:

Antes de comenzar: Se necesitan 2 o más personas para el ensamblaje. Tiempo aproximado: 2 horas.



150 Callender Road
Watertown, CT 06795
www.shelterlogic.com

1-800-524-9970

Canada:
1-800-559-6175

ATENCIÓN:

Este producto del cobertizo se diseña con el material de más alta calidad disponible. Se diseña para caber la cubierta de tela de encargo de **ShelterLogic®**, LLC incluida. Los cobertizos de **ShelterLogic®**, LLC ofrecen almacenaje y la protección contra el daño causado por el sol, la lluvia ligera, la savia del árbol, excremento de animal o pájaros y la nieve ligera. Por favor ancle esta estructura de **ShelterLogic®**, LLC correctamente. Vea el manual para más detalles de anclaje. El anclaje apropiado, manteniendo la cubierta apretada y libera de nieve y la basura o desechos es la responsabilidad del consumidor. Por favor lea y entienda el detalle de la instalación, las advertencias y las precauciones antes de la instalación final. Si usted tiene cualquier pregunta llame el número del servicio de atención al cliente enumerado en la cubierta del manual. Refiera por favor a la garantía incluida con su compra.

PELIGRO:

Antes de instalar consulte con su municipio sobre los códigos que puedan tener sobre este tipo de cobertizo. Seleccione la localidad de su cobertizo cuidadosamente. **Peligro: Aléjese de líneas de energía eléctrica.** Revise que no haya líneas de energía eléctrica, ramas de árboles u otras estructuras que puedan descargar nieve, hielo o escurrimientos sobre su cobertizo. Compruebe para saber si hay tubos o alambres bajo tierra antes de empezar a varar. NO cuelgue objetos del techo o de los cables de soporte.

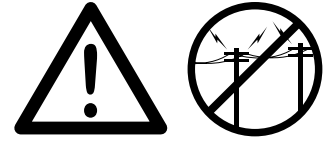

ADVERTENCIA:

Riesgo de fuego. No fume o utilice aparatos con una flama descubierta en o alrededor del cobertizo. NO cuelgue objetos del techo o en los cables de soporte. Utilice implementos de fuego abierto dentro de o cerca del cobertizo. NO guarde líquidos inflamables (gasolina, querosina, propano, etc.) en su cobertizo. No exponga la parte superior o los lados de su cobertizo a un fuego abierto u otras fuentes de fuego. NO utilice parillas, fosas con fuego, aparatos para freír o para ahumar dentro del cobertizo.



PRECAUCIÓN:

Tenga cuidado al erigir el marco. Utilice gafas de seguridad durante la instalación. Asegure y emperne juntos los postes de arriba durante la asamblea. Guárdese de los extremos del poste.

ANCLAJE APROPIADOS DEL MARCO SON LA RESPONSABILIDAD DEL CONSUMIDOR

ShelterLogic®, LLC no es responsable de daño a la unidad o al contenido. Por causas naturales, cualquier cobertizo que no se ancle con seguridad tiene el potencial para volar lejos estropeando causando daño, y no se cubre bajo la garantía. Compruebe periódicamente las anclas para asegurar la estabilidad del cobertizo. **ShelterLogic®**, LLC no puede ser responsable de ningún cobertizo que arranque. **NOTA:** La cubierta de su cobertizo se puede quitar y almacenar rápidamente antes de condiciones atmosféricas severas. Si fuertes vientos o el tiempo severo se pronostica en su área, recomendamos el retiro de la cubierta.

PARTES DE REEMPLAZO, ENSAMBLAJE, ORDENES ESPECIALES:

Las piezas y los accesorios genuinos de recambio de **ShelterLogic®**, LLC están disponibles de la fábrica, incluyendo los kits de anclaje para casi cualquier uso, cubiertas del reemplazo, kits de pared y del recinto, kits del respiradero y de luz, tubos del marco, puerta de cremallera y otros accesorios. Todos los artículos son enviados de la fábrica directamente a su puerta.

¿PREGUNTAS - DEMANDAS - ÓRDENES ESPECIALES? LLAME NUESTRO TELÉFONO DIRECTO DEL SERVICIO DE ATENCIÓN AL CLIENTE:

SERVICIO DE ATENCIÓN AL CLIENTE DE EE.UU.: 1-800-524-9970 SERVICIO CLIENTE INTERNACIONAL: 001-860-945-6442 SERVICIO CLIENTE DE CANADÁ: 1-800-559-6175

HORAS DE OPERACIÓN: 8:30 AM-8:00 PM DE LUNES-VIERNES HORA DEL ESTE, 8:30 AM-5:00 PM DE SABADO-DOMINGO HORA DEL ESTE

CUIDADO Y LIMPIEZA:

Una cubierta apretada asegurará funcionamiento y una vida más larga. Mantenga siempre una cubierta apretada. La tela floja puede acelerar la deterioración de la cubierta. Quite inmediatamente cualquier nieve o hielo acumulada en la estructura de la azotea con una escoba, fregona o otro instrumento suave. Tenga mucho cuidado al quitar nieve de la cubierta y siempre desde fuera de la estructura. No utilice el blanqueo o los productos abrasivos ásperos para limpiar la cubierta de tela. La cubierta se puede limpiar fácilmente con el jabón y agua. No utilice las herramientas o los instrumentos duro-afilados como los rastrillos o las palas para quitar nieve. Esto podría dañar y causar punturas a la cubierta.

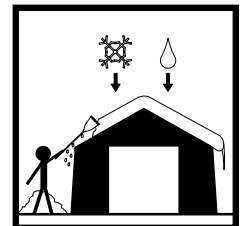













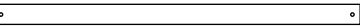
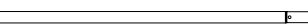

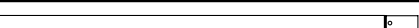
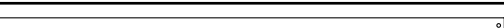

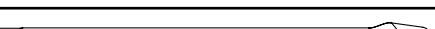
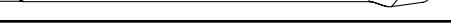
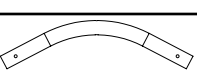
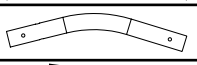
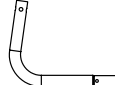



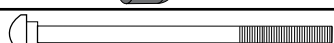
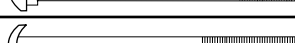
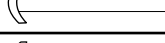



GARANTÍA:

Este cobertizo lleva una garantía limitada completa contra defectos en la ejecución de ser hechas. **ShelterLogic®**, LLC autoriza la garantía al comprador original que si está utilizado correctamente e instalado, el producto y todas las piezas asociadas, están libres de defectos del fabricante por un período de:

1 AÑO PARA LA TELA DE LA CUBIERTA, LOS PANELES DE EXTREMO Y EL MARCO

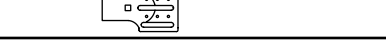
El período de garantía se determina mediante la fecha cuando se embarque de **ShelterLogic®**, LLC, para compras hechas directamente en la fábrica o la fecha de compra cuando se adquiere con un detallista autorizado, (por favor guarde su copia del recibo de compra). Si se encuentra que este producto o cualquiera de sus partes asociadas tienen algún defecto o faltan partes al momento de recibir el producto, **ShelterLogic®**, LLC reparará o reemplazará, de acuerdo a su opción, la parte defectuosa sin costo alguno para el comprador original. Partes de reemplazo o partes reparadas serán cubiertas durante el tiempo restante el Período de la Garantía Original Limitada. Todos los costos de embarque serán la responsabilidad del cliente. Las partes y reemplazos se mandarán por cobrar. Se deben de guardar los materiales de embalaje originales para el embarque de regreso. Si su compra la efectuó con un representante local, todas las reclamaciones deben de tener una copia del recibo original. Después de la compra, por favor llene y mande su tarjeta de garantía para así registrar su producto.

4 x 6,1 x 3,6m Garage-in-a-Box SUV/Truck® Las Partes Listan - Modelo n° 62693

Descripción de los Productos:	Cantidad	Pieza No.
 Rafter Poles, Swedged	12	802346
 Rafter Poles, not Swedged	12	802340
 Upright Poles	12	802636
 Upright Extension Poles	8	802347
 Upright Extension Corner	4	802348
 Rail Transversal, Swedged	20	802129
 Rail Transversal, non-Swedged	5	802130
 Sliding Cross Rail	10	10110
 Wind Brace, one end Swedged	4	802344
 Wind Brace, plain end	4	802345
 Top Bend	6	802341
 Side Bend	12	802343
 Foot Bend	4	802637
 Plato de acero de Pie	8	802342
 ShelterLock™ Bloque Estabilizador	24	800597
 Trinquete	8	10040
 Casquillos de Perno (Pour boulou 802497)	12	10150
 Cerrojos 6,4 x 85,7 mm (1/4 x 3 3/8 po)	24	802497
 Pernos Principales Redondos 6,4 x 76,2 mm (1/4 x 3 po)	6	802630
 Cerrojos 6,4 x 38,1 mm (1/4 x 1-1/2 po)	4	03025
 Cerrojos 6,4 x 41,2 mm (1/4 x 1-5/8 po)	56	10115
 Cerrojos 6,4 x 44,4 mm (1/4 x 1-3/4 po)	8	03034
 Cerrojos 6,4 x 47,6 mm (1/4 x 1-7/8 po)	36	03032
 Junta de Culata 6,4 mm (1/4 po)	20	01011
 Nueces 6,4 mm (1/4 po)	134	01010
 Abrazadera de 3 Maneras De Baranda de Cobertura	16	13201
 Abrazadera de 4 Maneras De Baranda de Cobertura	8	13202
 Cubierta	1	802337
 Puerta de 2 Cremalleras	1	802339
 Panneau arrière (solide)	1	802338
 Temporarias Anclas de Taladro 38,1 cm (15 po)	6	00847
 Cablegrafie longitudes 30 cm (12 po)	6	10016
 El cable Sujeta	6	10015
 RollUp Door Kit (boxed separately)	1	10077

1. DIAGRAMA DE LA ESTRUCTURA DEL TECHO

TRASERO

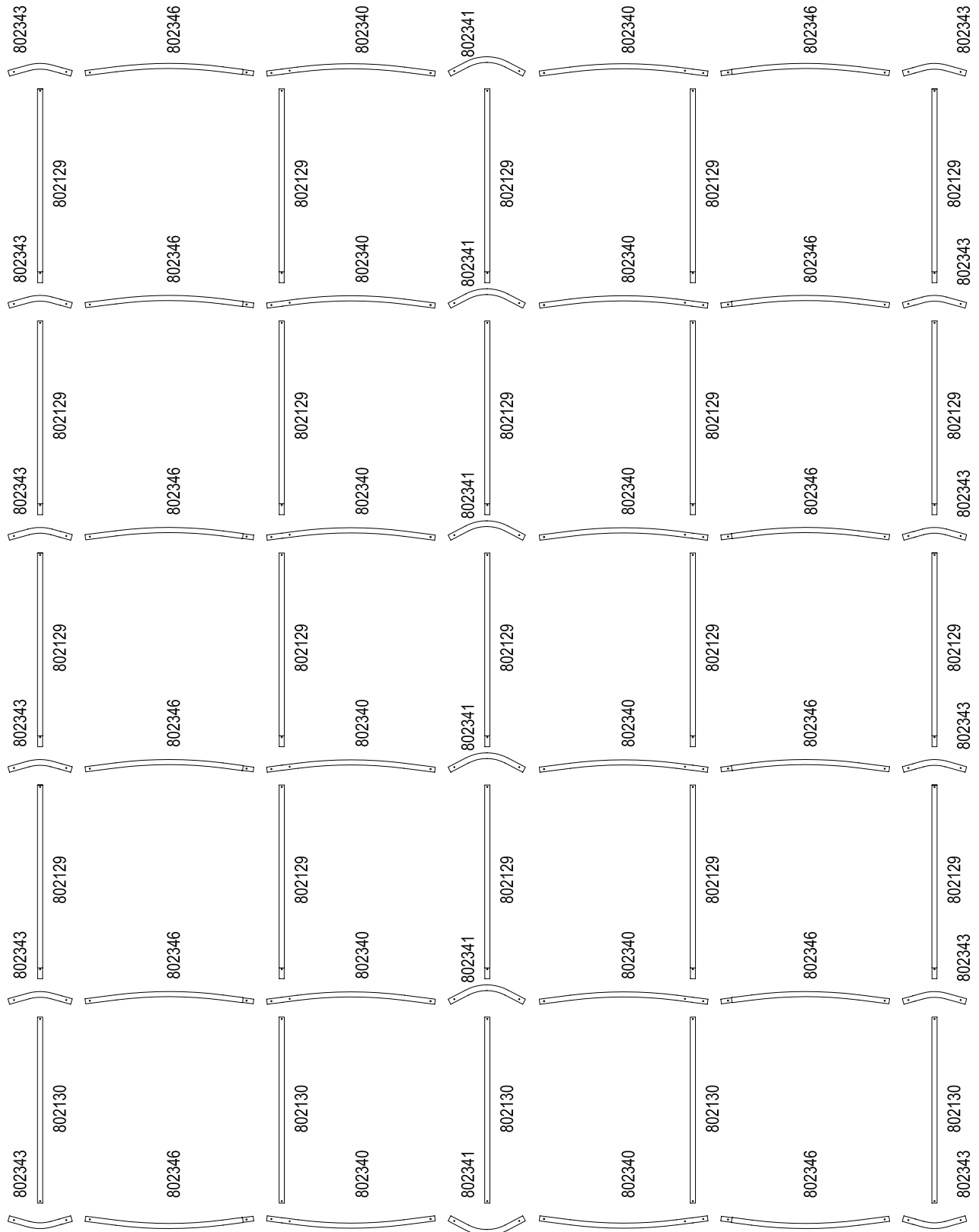

FRENTE

2. ENSAMBLE EL TECHO *Utilice los pernos según las indicaciones de ilustraciones*

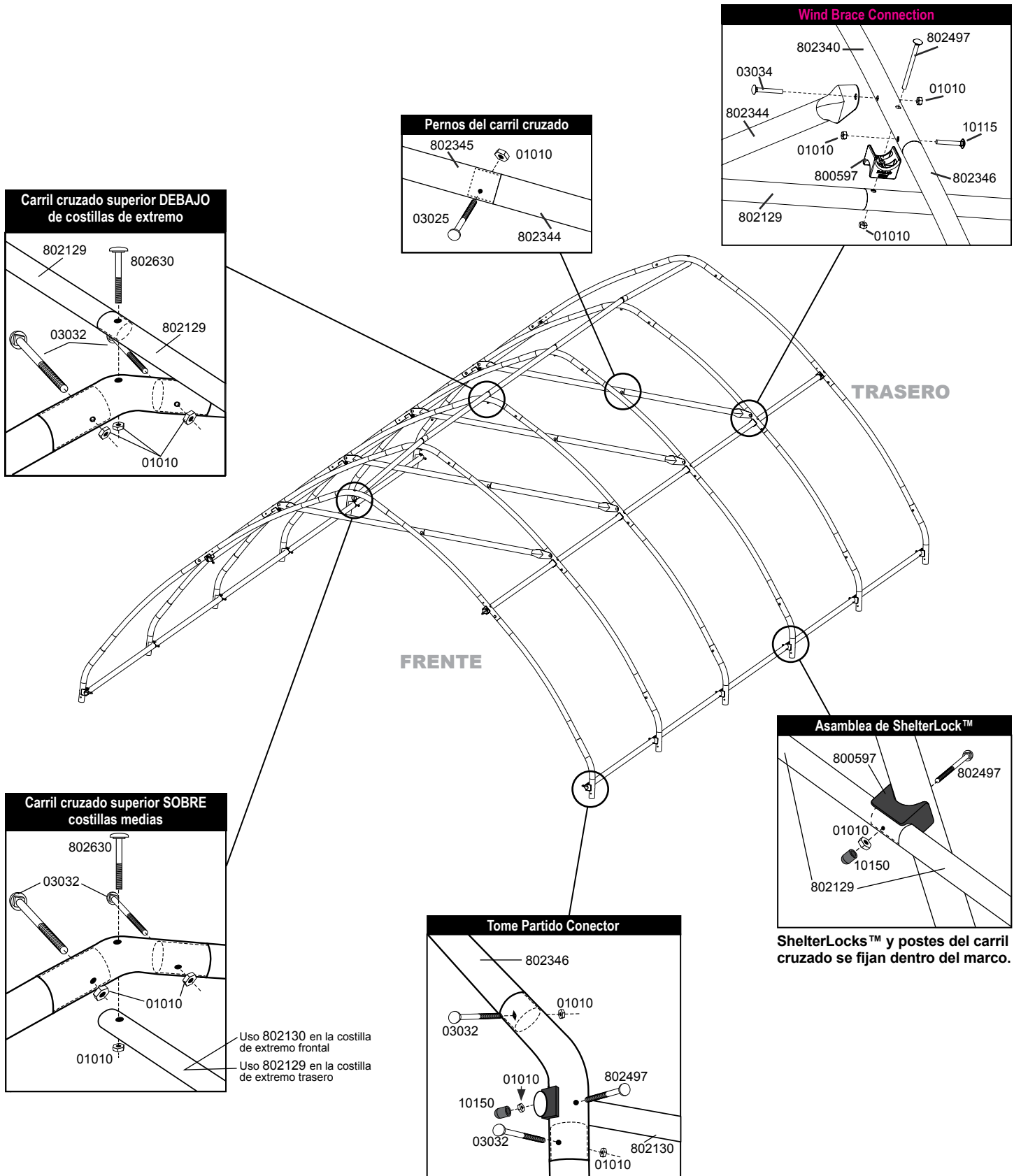

3. ENSAMBLE LOS PUNTALES RECTOS Y LAS PATAS

Utilice los pernos según las indicaciones de ilustraciones.

- A. Monte las piernas de la esquina y las piernas medias.
- B. Ate las piernas con los pernos en un lado del marco de la azotea.
- C. Ate las piernas restantes con los pernos al lado opuesto del marco de la azotea.

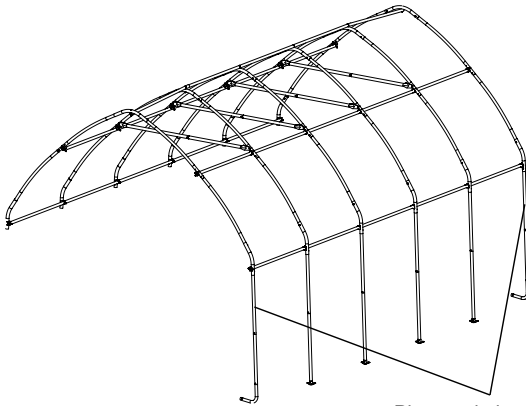
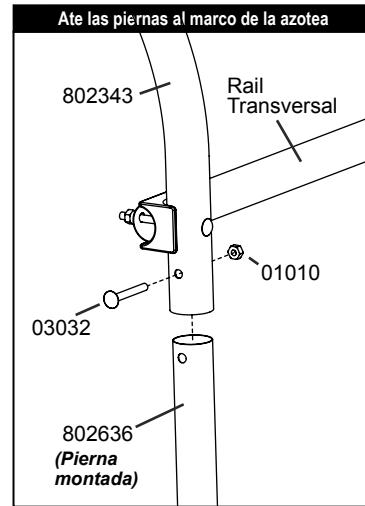
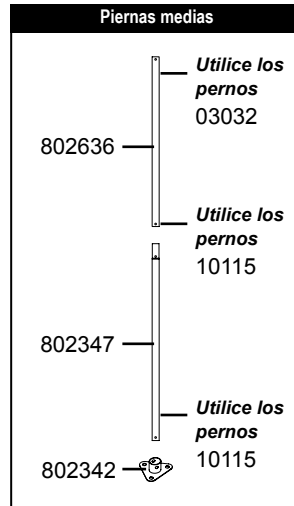
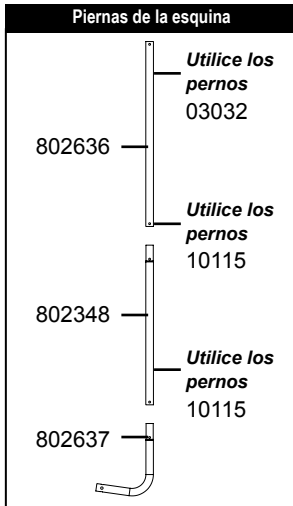

Piernas de la esquina

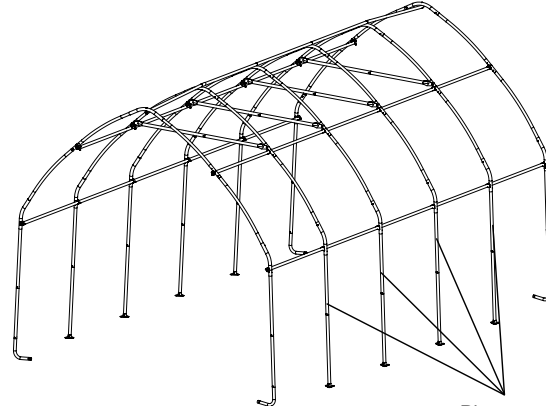

Piernas medias

4. MONTE LOS CARRILES DE LA CUBIERTA

- A. Coloque los largueros de cubierta (10110) en cada puntal y asegúrelos con una abrazadera de cubierta.
- B. Deslice los largueros de cubierta de modo que estén a 20,3 cm (8 pulgadas) de la tierra y apriete los pernos.

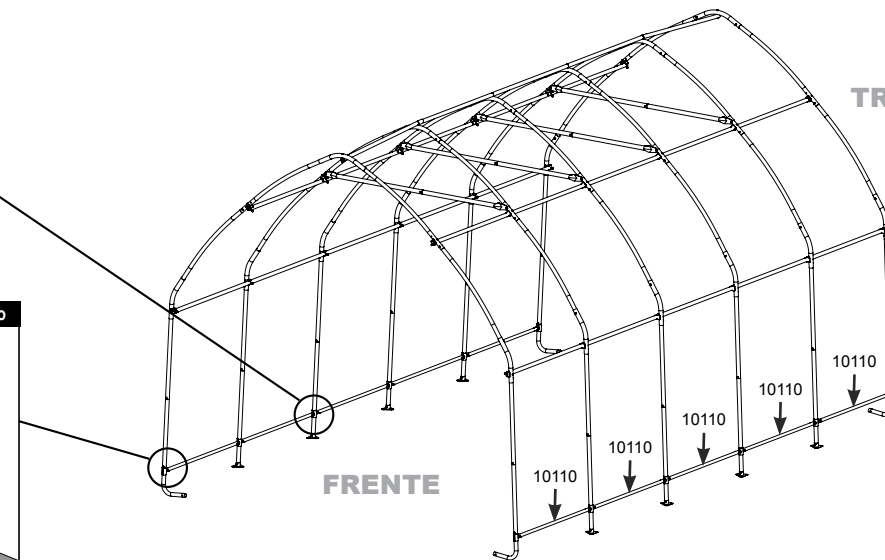
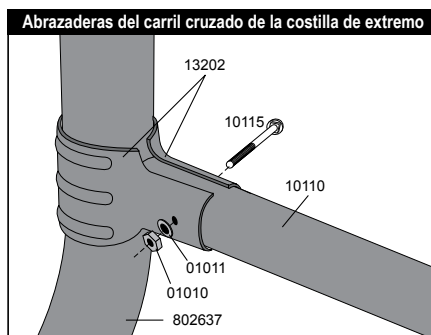
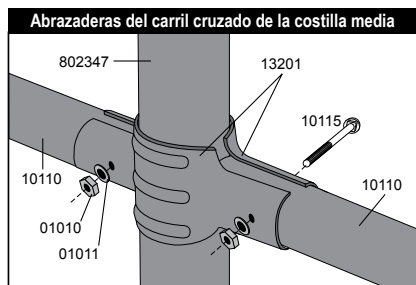

5. AJUSTANDO EL MARCO CUADRADO

- A. Ponga el marco en la localización final, que debe estar plano y nivel los mas que sea posible.
- B. Medida a través de esquinas opuestas. Estas dos distancias deben ser iguales dentro de 2,5 cm (una pulgada).
- C. Verifique que mida 4 m / 13' 2" in width.

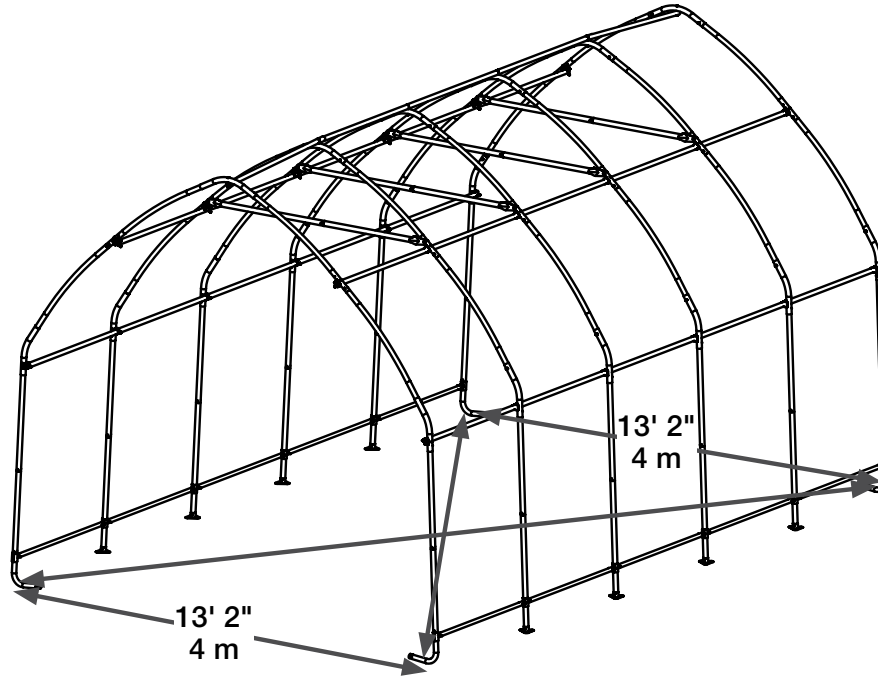

6. ANCLA CORRECTAMENTE EL MARCO

- A. Las anclas se deben colocar dentro del refugio en las esquinas del refugio.
- B. Inserte una tubo o barra de acero de \leq pulgadas = 1.905 centímetros a través del ojeteador del taladro y atornilla el ancla en la tierra hasta que el ojeteador se está pegando fuera de la tierra por 1-2 pulgadas = 2.54-5.08 centímetros para que pueda ser anclado a las piernas.

Si la tierra es demasiado dura, cave un hoyo con una herramienta de pala o de poste. OPCIONAL: Llene con cemento.

- C. Envuelva el cable proporcionado a través del ojeteador del ancla y alrededor del marco como se muestra abajo. Asegure el cable con las abrazaderas proporcionadas.

NOTA:

Los taladros de 15" pulgadas están para el uso temporal solamente! Para los mejores resultados ShelterLogic recomienda el usar de nuestros Ganchos Fáciles (#10036 4-paquetes, #10035 6-paquetes, o #10038 8-paquetes) o Taladros de 30" pulgadas (#10075 4-paquetes, #10078 6-paquetes, o #10079 8-paquetes) para una instalación más fuerte y más segura.

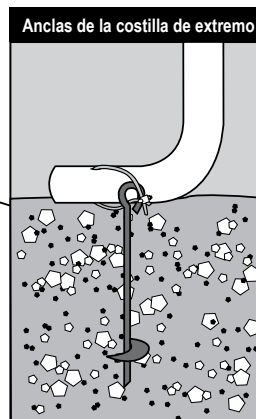

Llama 1-800-524-9920
o visita
www.shelterlogic.com
para más información.

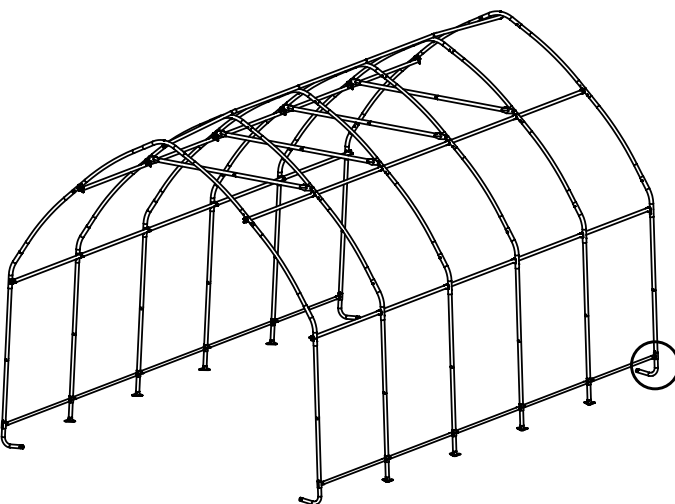

7. PUERTA E INSTALACIÓN DEL PANEL SÓLIDO DE EXTREMO

- A. Sostenga el panel de extremo en el centro superior con el revestimiento superficial interno blanco dentro del cobertizo. Envuelva los bordes del panel de la tela alrededor de la costilla de extremo y pase los carriles entre los boquetes en la tela.
- B. Desconecte el carril superior de la costilla de extremo. El carril cruzado superior debe pasar entre el boquete en la tela, y estar entre el marco de las correas y de la costilla. Repita el paso B para los carriles cruzados laterales.
- C. En bas, la ou la sangle sort de la poche de chaque coté du panneau, tirez sur la sangle pour tendre le panneau. **Faite bien attention de ne pas trop tirez sur la sangle pour évitez qu'elle disparaisse de l'autre coté du panneau.**
- D. Insérez le crochet en "S" dans le trou du coin courbé de la jambe. Insérez la sangle dans le cliquet et tirez fort. Remontez le cliquet jusqu'à ce que la sangle s'enroule autour d'elle-même. **Positionnez le panneau de manière à ce qu'il soit bien centré sur l'abri.**
- E. Serrez les cliquets, en alternant d'un coté à l'autre, jusqu'à ce que le panneau soit bien tendu.

Los paneles de la puerta de cremallera: Las cremalleras deben ser cerradas al apretar el panel de extremo.

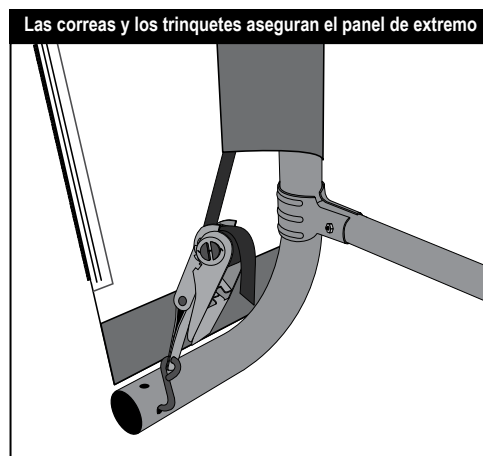
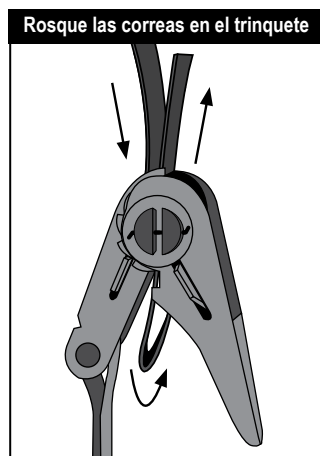
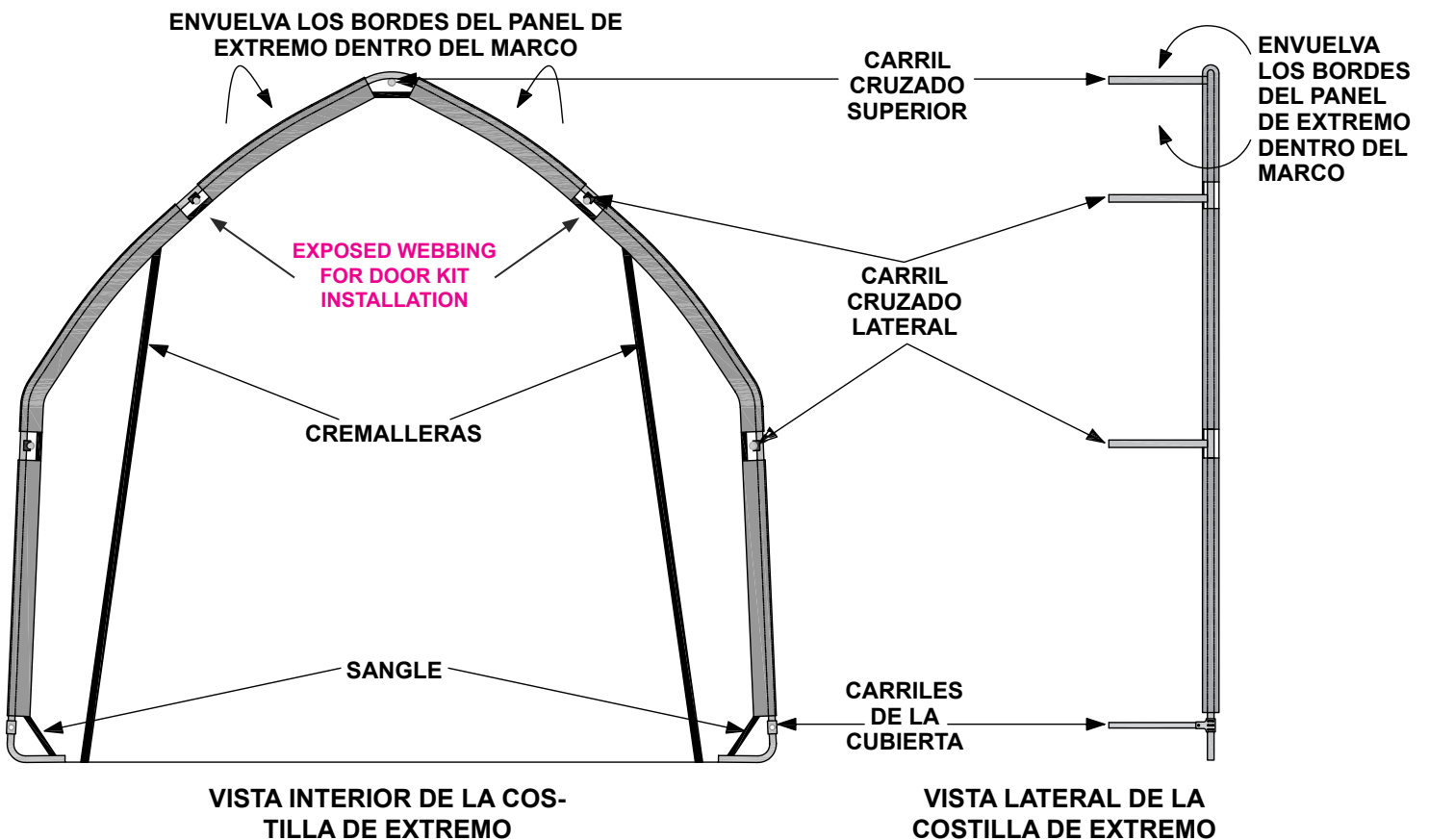

8. COLOCACIÓN DE LA CUBIERTA Y DE LOS LARGUEROS DE LA CUBIERTA

- Coloque la cubierta en la tierra al lado de la estructura con la parte interior de la cubierta (el lado con los compartimientos para el tubo) orientada hacia abajo y el lado del tejido del frente y posterior de la esquina de la unidad.
- Hale la cubierta sobre la estructura. Debe haber una cantidad igual de proyección en las cuatro esquinas.
- Inserte el gancho en "S" del trinquete en el agujero del codo de la pata. Inserte el tejido en el eje del trinquete y hale hasta que apriete. Déle vuelta al trinquete hasta que el tejido se solape sobre sí mismo.
- Desmonte los largueros de la cubierta y deslícelos a través de los compartimientos de tela en cada pata y vuelva a asegurar con abrazaderas. Repita para el otro lado. Presione hacia abajo en los largueros de la cubierta para apretar la cubierta antes de apretar los pernos completamente.
- Verifique y apriete los trinquetes y los largueros transversales mensualmente para comprobar que la cubierta quede apretada.

IMPORTANT NOTE: Your pre-packed Roll-Up Door Kit includes a manual that instructs you to cut holes for installation (Step F). The GIB SUV/Truck includes grommets in the cover especially for this Door Kit. DO NOT cut holes as instructed in Step F.

