

Monarc Canopy™

10' x 18' / 3 x 5,5 m

#25867

TEMPORARY STRUCTURE
STRUCTURE TEMPORAIRE
ESTRUCTURA TEMPORAL



= Helpful information
= Informations utiles
= Información útil

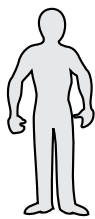
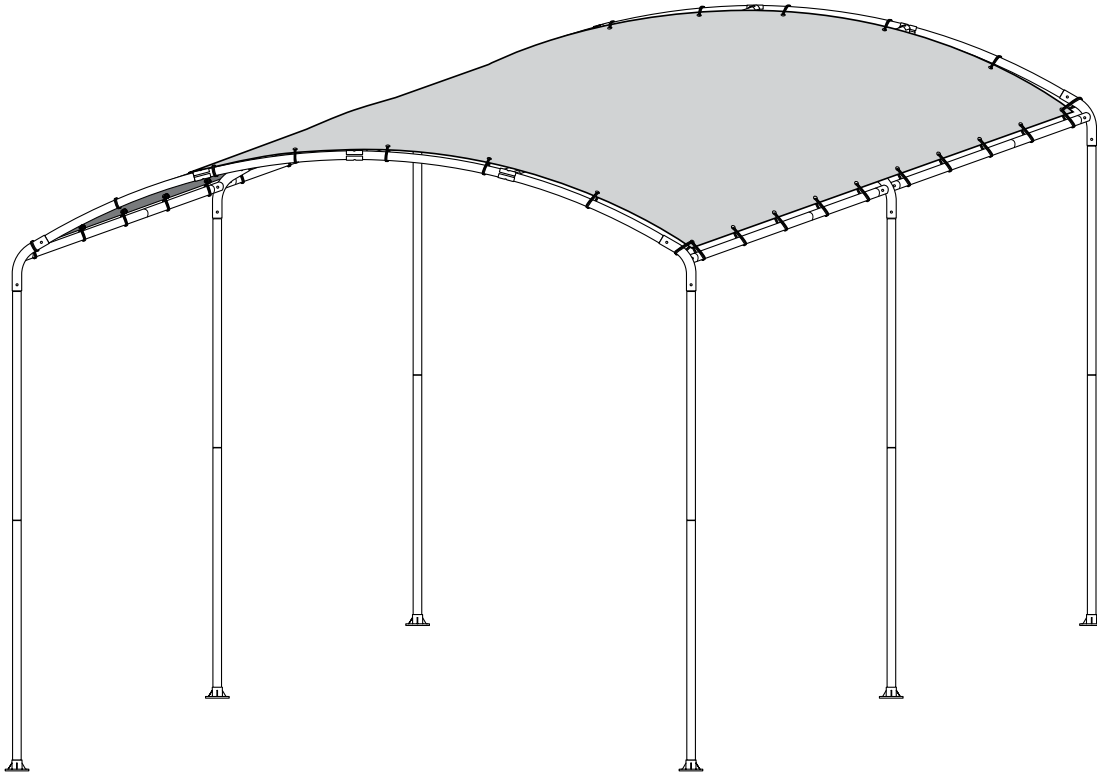

x2+

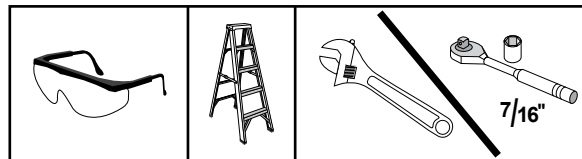

150 Callender Road
Watertown, CT 06795
www.shelterlogic.com

1-800-524-9970

Canada:
1-800-559-6175

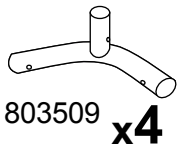

803509 **x4**

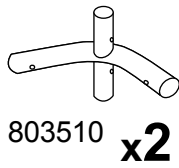

803510 **x2**

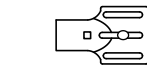

803518 **x12**

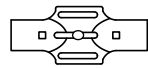

803517 **x6**

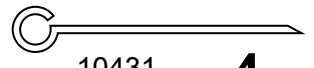

10431 **x4**



01010 **x63**

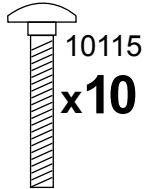

10115 **x10**



03032 **x20**



10017 **x27**

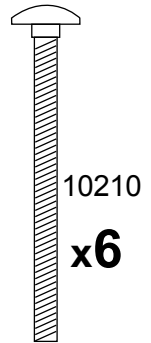

10210 **x6**

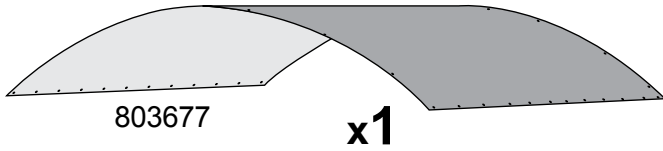

803677 **x1**

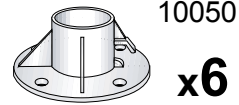

10050 **x6**



00748 **x40**

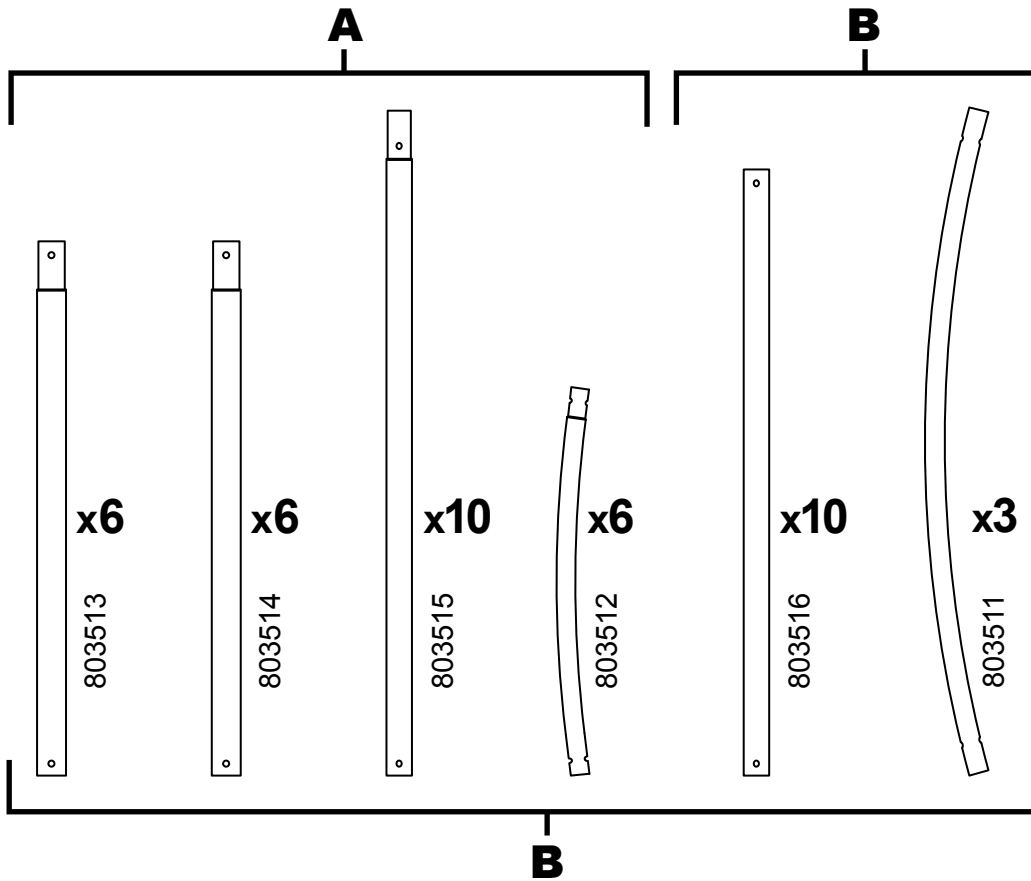

1.

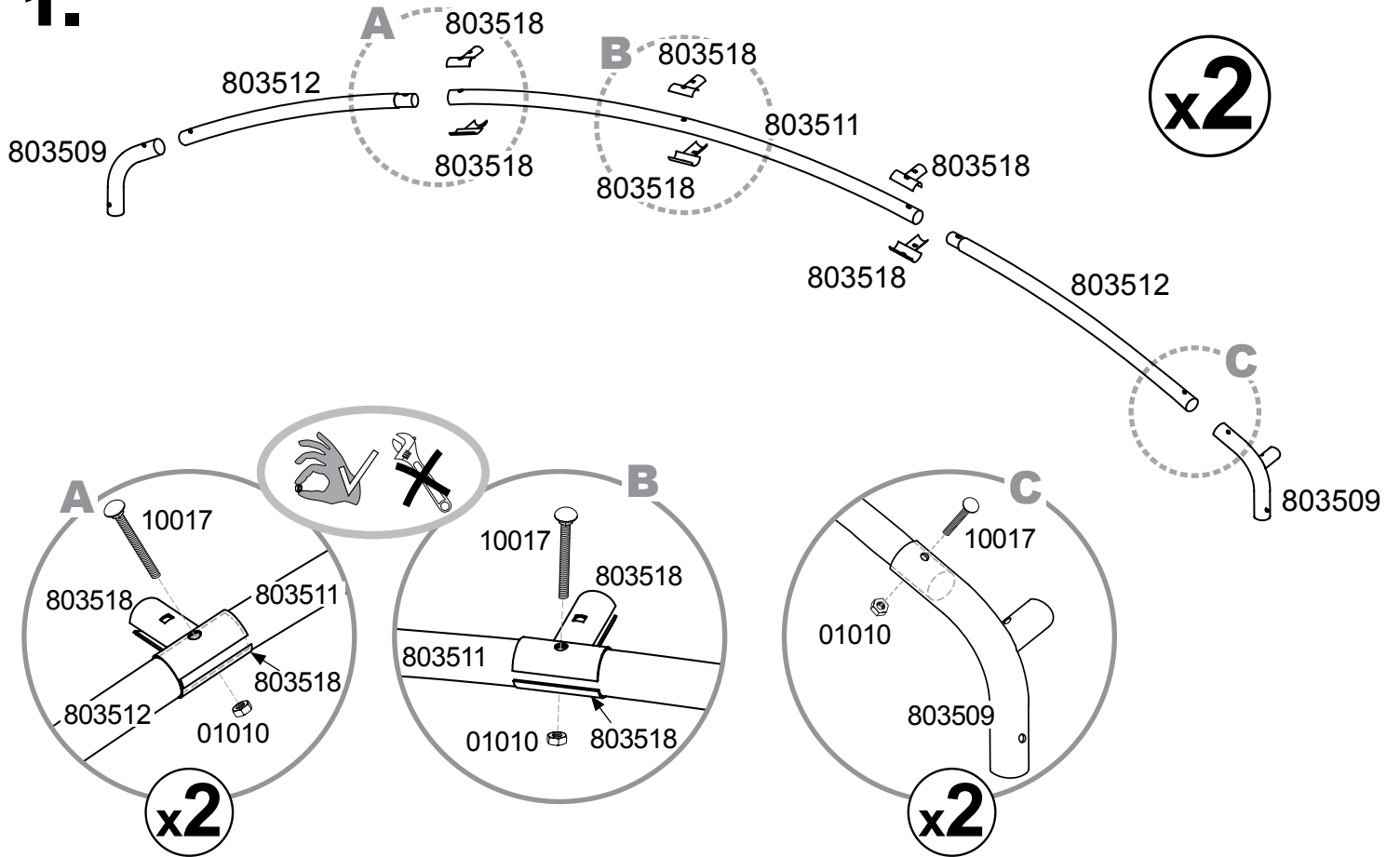

2.

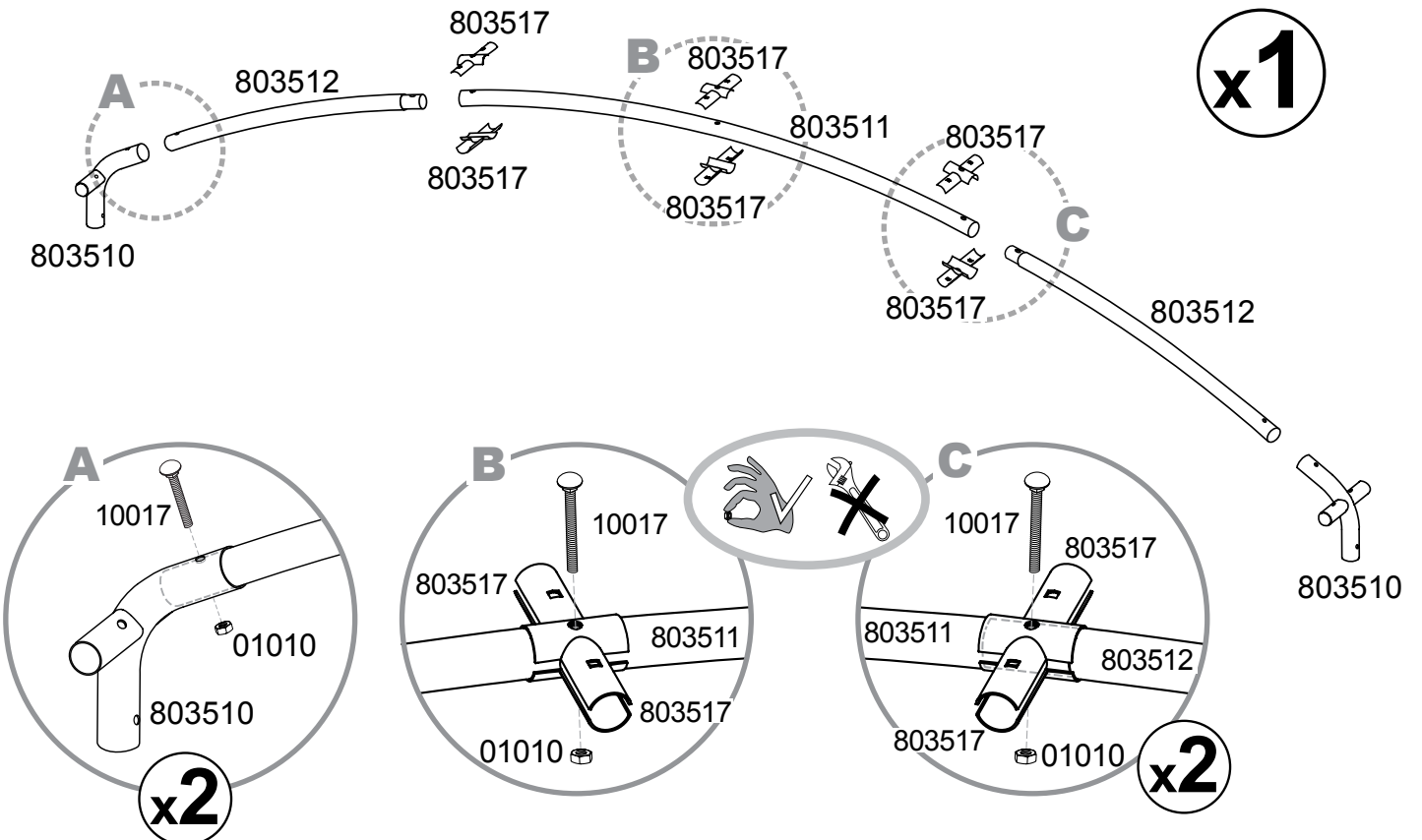

3.

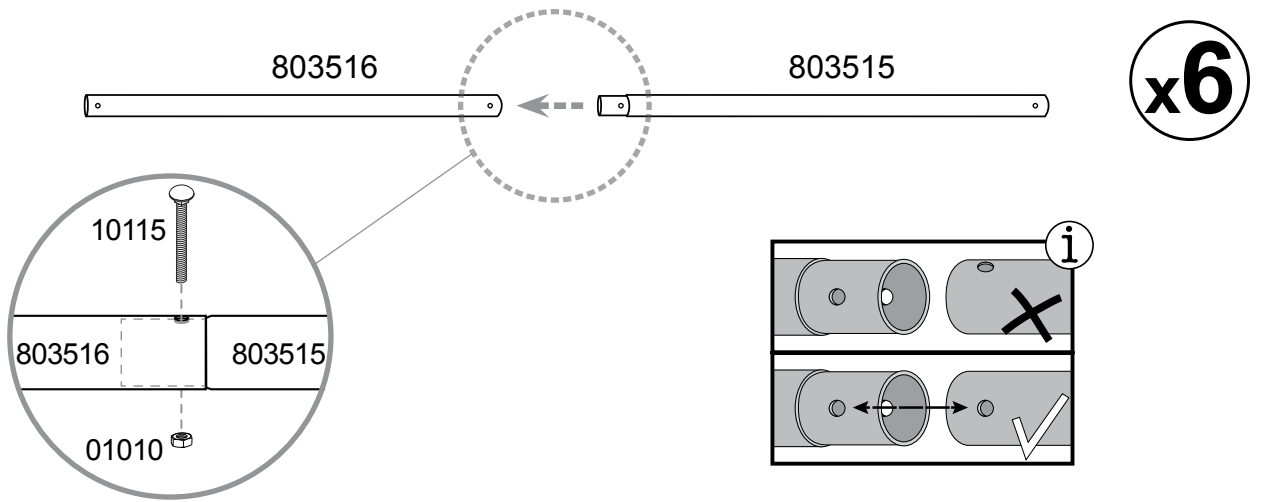

4.

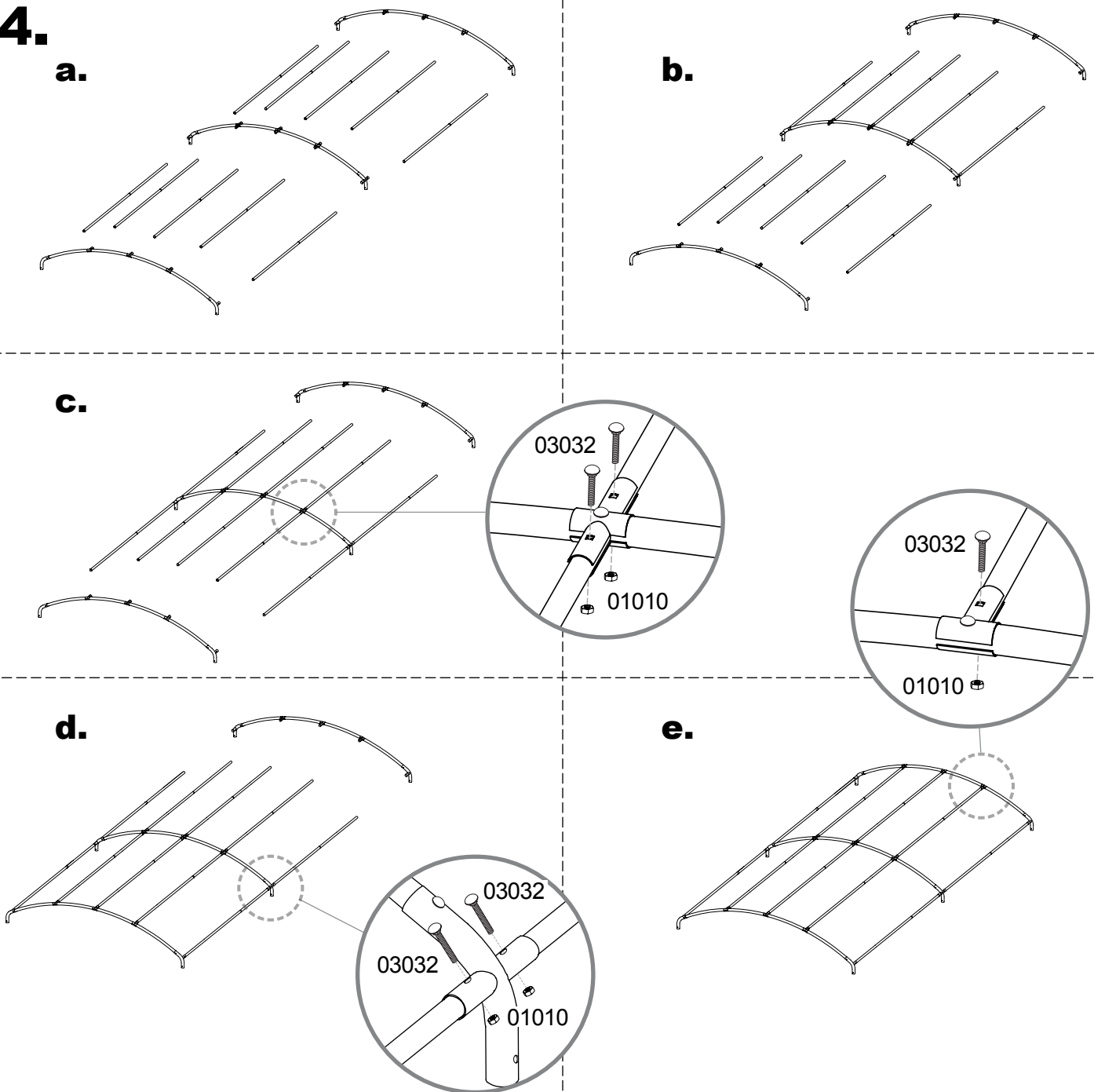

5.

a.

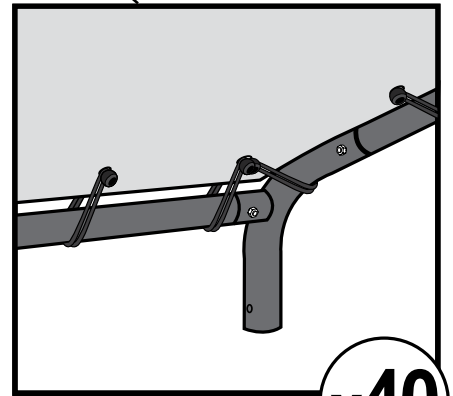
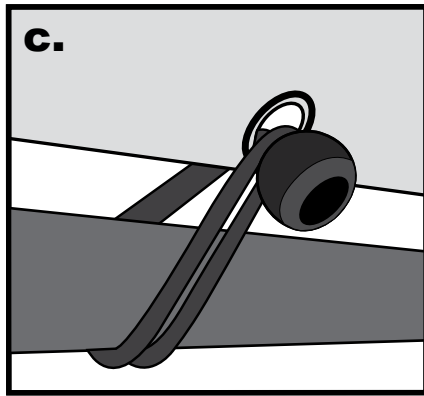
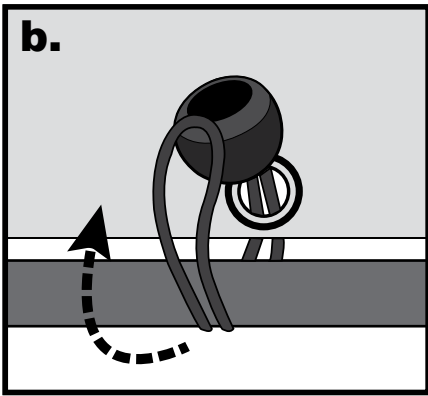
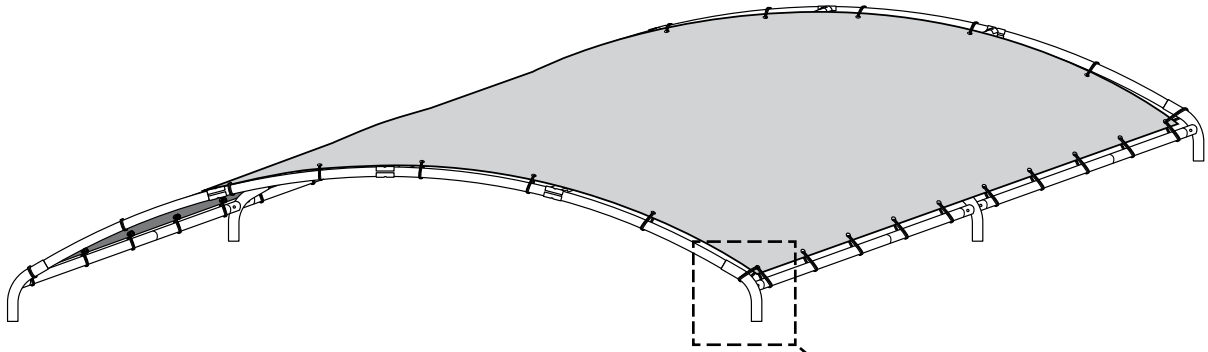
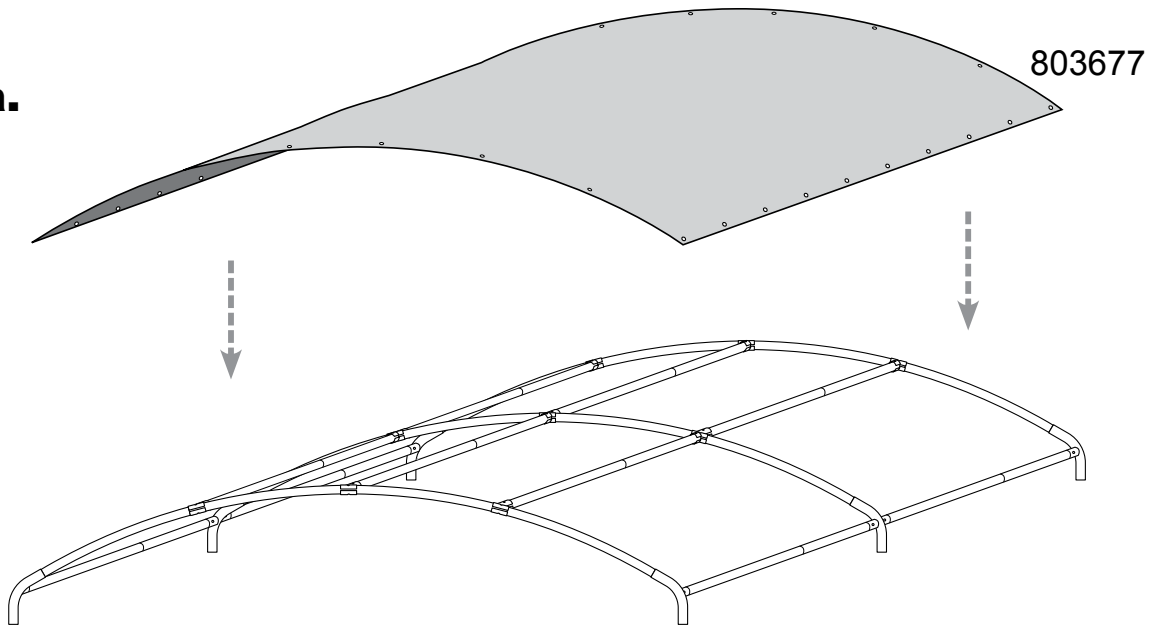

x40

6.

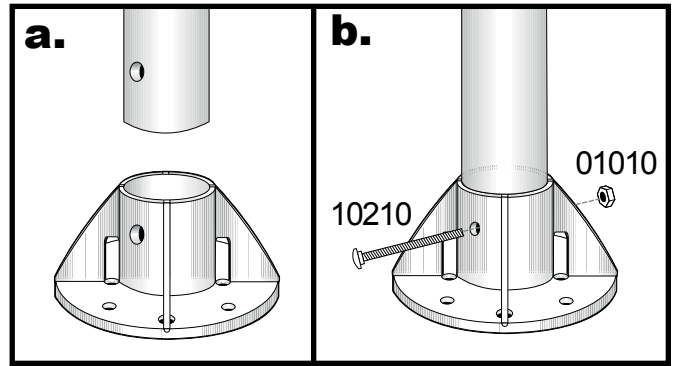
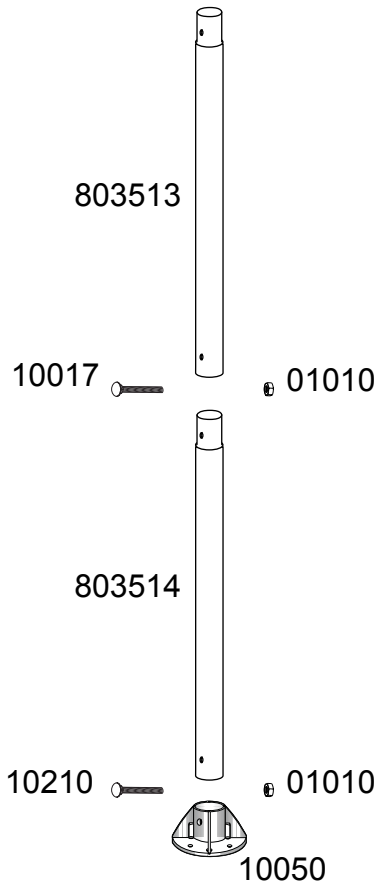

x6

7.a.

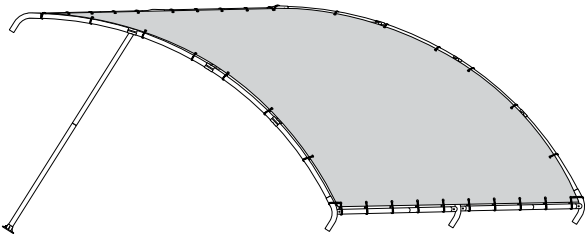

b.

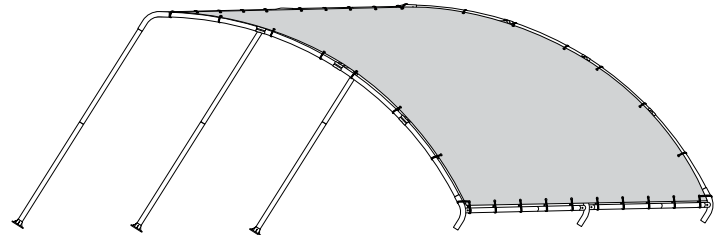

c.

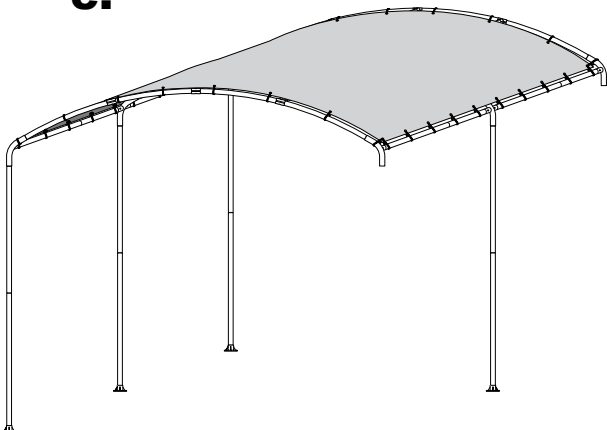

d.

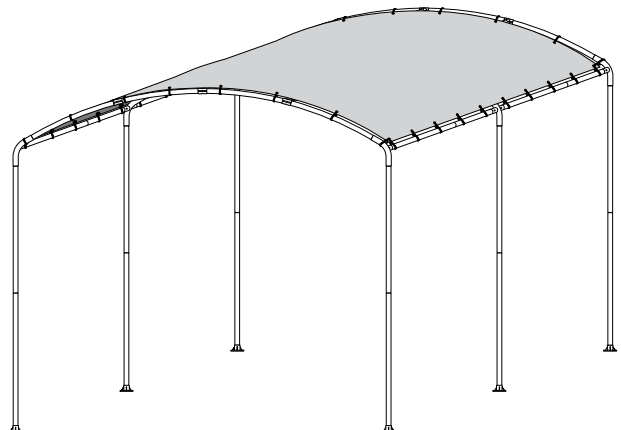

ANCHOR GUIDE / GUIDE D'ANCRAGE / GUÍA DEL ANCLA

ShelterLogic shelters, canopies and garages come with a basic "install" end rib anchor kit to secure and square-up the frame during installation. In most situations, additional anchors are recommended. ShelterLogic suggests one anchor per leg.

Tous les abris et tentes ShelterLogic viennent avec un kit d'ancrage basique "d'installation", pour chaque bout de l'abri, pour sécuriser et bien installer la charpente et s'assurer qu'elle soit rectangulaire. Dans la plus part des situations, des ancrs additionnelles sont recommandées. ShelterLogic vous suggère une ancre par pieds.

Los refugios, los toldos y los garajes de ShelterLogic vienen con un básico "instalar" el juego del ancla de la costilla del extremo para asegurar y encuadrar - para arriba el marco durante la instalación. En la mayoría de las situaciones, se recomiendan las anclas adicionales. ShelterLogic sugiere una ancla por pierna.

SHEDS, GARAGES, GREENHOUSES, STORAGE SHELTERS

GARAGES, ABRIS ET ABRI DE STOCKAGE

GARAJES, COBERTIZOS Y REFUGIOS DEL AMANCENAJE



CANOPIES, POP-UP CANOPIES

AUVENTS FIXES ET ESCAMOTABLES

TOLDO FIJO Y PLEGABLE



Anchors not shown to scale.
Ancres ne sont pas montrées à échelle.
Anclas no demostradas a la escala.

	A	B	C	D	E	C	F	G
PACKED SOIL SOL COMPACT COMPACTO TIERRA	✓	✓	✓			✓	✓	✓
SAND SABLE ARENA	✓	✓	✓			✓		✓
GRAVEL GRAVIER GRAVILLA	✓	✓					✓	✓
CLAY ARGILE ARCILLA	✓	✓	✓			✓	✓	✓
ASPHALT ASPHALTE ASFALTO	✓	✓					✓	✓
Drill hole in asphalt Perçer un trou dans l'asphalte Taladrar un hoyo en asfalto								
CONCRETE BETON HORMIGÓN			✓	✓		✓		✓
Embed in wet concrete Placer dans le béton humide Encaje en hormigón húmedo								
WOOD BOIS MADERA					✓			✓



8.

